

# 0 SERIES FIXED REMODEL

PROJECT NAME:	TYPE:
---------------	-------

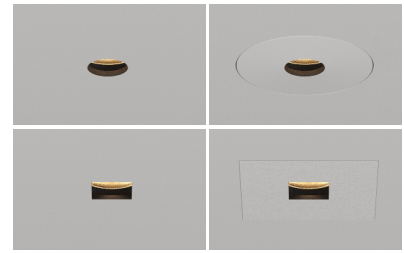

- Max output of 990Lm at 80+ CRI
- Available with trimless and zero sightline baffles, featuring 0.5" aperture

## ORDERING INFORMATION - FIXTURE

TRIM	RATING	TYPE	BAFFLE & MOUNTING	EXTERIOR FINISH	INTERIOR FINISH	CRI	WATTAGE	CCT	OPTIC	MEDIA	INSTALL TYPE	CEILING THICKNESS	DRIVER
		<b>F</b>			<b>BK</b>							<b>1</b>	
ORM 1/2" Round Micro	1 IP20 Dry/Damp	F Fixed	T Trimless	<b>TRIMLESS</b> TG Trimless Gypsum* *(Required for trimless gypsum)	BK Black	<b>STATIC WHITE</b>	<b>STATIC WHITE</b>	24 2400K* *(90 CRI only)	20 20°	NL No Lens	REMODEL	1 0.50" - 1.50"	<b>REMOTE</b>
OSM 1/2" Square Micro	2 IP64 Wet		G Zero Sightline Gypsum	<b>ZERO SIGHTLINE</b> POWDERCOAT WH White AG Satin Silver AU Cashmere Gold AB Architectural Bronze BB Burnt Bronze BK Black SB Specular Black PR Primer CF Custom Finish *(Consult Factory) <b>ALUMINA</b> 01 Brushed Obsidian 02 Matte Obsidian 03 Brushed Dark Patinated Bronze 04 Matte Dark Patinated Bronze 05 Brushed Aged Aluminum 06 Matte Aged Aluminum 07 Brushed Cast Brass 08 Matte Cast Brass 09 Brushed Light Patinated Bronze 10 Matte Light Patinated Bronze	<b>FINISH IMAGES ON PAGE 2</b>	80S 80+ CRI 90S 90+ CRI 95S 95+ CRI	06C 6W, 416 Lm 11C 11W, 634 Lm 15C 15W, 842 Lm <b>ZERO SIGHTLINE</b> 06C 6W, 423 Lm 11C 11W, 644 Lm 15C 15W, 856 Lm	27 2700K 30 3000K 35 3500K 40 4000K	30 30° 40 40°	01 Clear Film* *(Required for wet location)	RR Remote Remodel		PH1 Forward / Reverse Phase, 2%, 120V SG5 eldoLED, ECOdrive 1%, 0-10V, LOG, 120V-277V SN5 eldoLED, ECOdrive 1%, 0-10V, LIN, 120V-277V EG1 eldoLED, SOLOdrive 0.1% 0-10V, LOG, 120V-277V EN1 eldoLED, SOLOdrive 0.1% 0-10V, LIN, 120V-277V ED1 eldoLED, SOLOdrive 0.1% DALI-2, LOG, 120V-277V LP1 Lutron, Hi-Lume Premier Ecosystem 0.1% Fade to Black, 120V or 277V AS1 / ASR Athena Control eldoLED, SOLOdrive 0.1%, 120V-277V* *(Includes Athena Node. Extended lead time, consult factory. ASR includes remote shunt) CS1 / CSR Casambi Control eldoLED, SOLOdrive 0.1%, 120V-277V* *(Includes Casambi Node. Extended lead time, consult factory. CSR includes remote shunt) HUB Distributed Power System, Powers up to 6 Fixtures* *(Requires further specification on page 2)
						90L 90+ CRI	<b>WARM DIM</b>						
							<b>WARM DIM TRIMLESS</b>						
							11D 11W 15D 15W Incandescent Profile 11W - 373 Lm 15W - 493 Lm	WL 2700K-1800K		40 40°			
							Halogen Profile 11W - 395 Lm 15W - 525 Lm	WD 3000K-1800K					
							<b>ZERO SIGHTLINE</b>						
							11D 11W 15D 15W Incandescent Profile 11W - 384 Lm 15W - 508 Lm	WL 2700K-1800K		40 40°			
							Halogen Profile 11W - 406 Lm 15W - 540 Lm	WD 3000K-1800K					
							<b>DELIVERED LUMEN OUTPUTS REFLECT 90CRI, 3000K, 40° OPTIC, AND NO LENS.</b>						

### PART NUMBER NOTES

- Fixture ships as e.g., ORM1FTTGAUBK90S15C3540NLRR1SG5
- Housing, driver, trim, and applique ship as one unit

# 0 SERIES FIXED REMODEL

## ACCESSORIES

### CONFIGURATION - REQUIRED FOR 'HUB' DRIVER SPECIFICATION

ASSEMBLY	QTY	WATTAGE	REMOTE DRIVER
<b>HUB</b>			
<b>DISTRIBUTED POWER HUB</b>	2X 2 Fixtures 3X 3 Fixtures 4X 4 Fixtures 5X 5 Fixtures 6X 6 Fixtures	06W 6 Watts 11W 11 Watts 15W 15 Watts	PH1 Forward/Reverse Phase, 2%, 120V SG5 eldoLED, ECOdrive 1%, 0-10V, LOG, 120V-277V SN5 eldoLED, ECOdrive 1%, 0-10V, LIN, 120V-277V EG1 eldoLED, SOLdrive 0.1% 0-10V, LOG, 120V-277V EN1 eldoLED, SOLdrive 0.1% 0-10V, LIN, 120V-277V ED1 eldoLED, SOLdrive 0.1% DALI-2, LOG, 120V-277V AS1/ASR Athena Control, eldoLED, SOLdrive, 0.1%, 120V-277V* <i>*(Includes Athena Node. Extended lead time, consult factory. ASR includes remote shunt)</i> CS1/CSR Casambi Control eldoLED, SOLdrive, 0.1%, 120V-277V* <i>*(Includes Casambi Node. Extended lead time, consult factory. CSR includes remote shunt)</i> LP1 Lutron, Hi-Lume Premier Ecosystem 0.1% Fade to Black, 120V or 277V

### PART NUMBER NOTES

- Configuration e.g. HUB2X15WPH1, ordered as separate line item
- HUB ships as e.g., HUB2X15WPH1

## ACCESSORIES

### REPLACEMENT OPTICS

Interchangeable optics accessible through fixture aperture.

- RO-17-20** 20° optic
- RO-17-30** 30° optic
- RO-17-40** 40° optic

### REPLACEMENT BAFFLE ASSEMBLY (INCLUDES MEDIA)

ASSEMBLY	SHAPE	RATING	TYPE	BAFFLE	EXTERIOR FINISH	INTERIOR FINISH	MEDIA
<b>RBA</b>			<b>F</b>			<b>BK</b>	
<b>REPLACEMENT BAFFLE ASSEMBLY</b>	0RM Round 0SM Round	1 IP20 Dry/Damp 2 IP64 Wet* <i>*(Baffle removal tool provided for aim and focus)</i>	<b>F</b> Fixed	T Trimless G Zero Sightline M Trimless Millwork	TG Trimless Gypsum WH White AG Satin Silver AU Cashmere Gold AB Arch. Bronze BB Burnt Bronze BK Black PR Primer CF Custom Finish* <i>*(Consult Factory)</i> <i>*See page 1 for Alumina finish options</i>	BK Black	NL No Lens 01 Clear Glass Lens

### REPLACEMENT INSTALLATION TOOLS

One included with every six fixtures designated Wet location.

- 01S-TOOL-BAFFLE-REMOVAL** Allows for baffle removal with Wet location
- 01S-TOOL-ENGINE-INST-REMOVAL** Allows for installation of LED module
- 01S-TOOL-ENGINE-BAFFLE-COMBO** Includes both baffle removal tool and LED installation tool

### HANGER BAR EXTENDER KIT

Extends hanger bars from 24.0" to 46.0" maximum.

- FRX-HBE-46** Extender, Hanger Bar

### EMERGENCY LIGHTING - REMOTE MOUNT ONLY

During disruption of main power, emergency battery inverter provides temporary 120V or 277V to fixture.

- EMB-S-25-120/277-LEDX** 25 watt max capacity, 120 or 277 VAC 60Hz, Non-Dimmable
- EMB-S-100-120-LEDX** 100 watt max capacity, 120 VAC 60Hz, 0-10V Dimmable
- EMB-S-100-277-LEDX** 100 watt max capacity, 277 VAC 60Hz, 0-10V Dimmable
- EMB-S-250-120/277-LEDX** 250 watt max capacity, 120 or 277 VAC 60Hz, 0-10V Dimmable

**\*SHUNT REQUIRED FOR USE WITH ATHENA AND CASAMBI CONTROLS, CONSULT FACTORY FOR DETAILS.**

### COMPATIBILITY BY DRIVER TYPE AND QUANTITY

DRIVER	HUB2X			HUB3X			HUB4X			HUB5X			HUB6X		
	06W	11W	15W	06W	11W	15W	06W	11W	15W	06W	11W	15W	06W	11W	15W
<b>PH</b>	✓	✓	✓	✓	✓	✓	✓	✓	✓	✓	✓	✓	✓	✓	✓
<b>SG/SN</b>	✓	✓	✓	✓	✓	✓	✓	✓	✓	✓	✓	✓	✓	✓	✓
<b>EG/EN/ED</b>	✓	✓	✓	✓	✓	✓	✓	✓	✓	✓	✓	✓	✓	✓	✓
<b>AS/CS</b>	✓	✓	✓	✓	✓	✓	✓	✓	✓	✓	✓	✓	✓	✓	✓
<b>LP1</b>	✓	✓	✓	✓	✓	✓	✓	✓	✓	✓	✓	✓	✓	✓	✓

## POWDERCOAT FINISHES

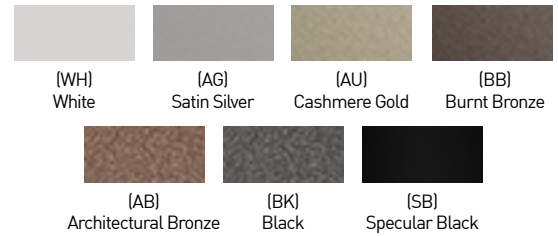

## ALUMINA FINISHES BY LUCIFER LIGHTING™



# 0 SERIES FIXED REMODEL

## PERFORMANCE - TRIMLESS - 3000K - NO LENS

LUMEN PACKAGE	WATTS	20° OPTIC		30° OPTIC		40° OPTIC	
		DLVD	LPW	DLVD	LPW	DLVD	LPW
80S06C	6	215	36	389	65	481	80
80S11C	11	327	30	592	54	733	67
80S15C	15	435	29	787	52	974	65
90S06C	6	186	31	336	56	416	69
90S11C	11	283	26	512	47	634	58
90S15C	15	376	25	680	45	845	56
95S06C	6	134	22	242	40	299	50
95S11C	11	203	18	368	33	455	41
95S15C	15	270	18	489	33	605	40
90L11DL (27K-18K)	11	-	-	-	-	373	34
90L11DD (30K-18K)	11	-	-	-	-	493	33
90L15DL (27K-18K)	15	-	-	-	-	395	36
90L15DD (30K-18K)	15	-	-	-	-	525	35

OUTPUT MULTIPLIER	
CCT	CCT SCALE
2400K	0.89
2700K	0.98
3000K	1.00
3500K	1.09
4000K	1.14

MEDIA LIGHT LOSS MULTIPLIER	
MEDIA	LIGHT LOSS FACTOR
NO LENS	1.00
LENS	0.93

FINISH MULTIPLIER	
CCT	CCT SCALE
WHITE	1.00
BLACK	0.98
SPECULAR BLACK	0.98

## WARM DIM PERFORMANCE - NO LENS - 40° OPTIC

INCANDESCENT PROFILE - TRIMLESS

90L11DL 2700K - 1800K	Full on 100%	Dimmed to 80%	Dimmed to 70%	Dimmed to 50%	Dimmed to 20%	Dimmed to 10%	Dimmed to 2%
CCT (K)	2700K	2700K	2700K	2700K	2500K	1900K	1800K
Light Output (Lm)	373	298	261	187	75	37	7
Power (W)	11	8.8	7.7	5.5	2.2	1.1	0.2
Efficacy (LPW)	34	34	34	34	34	34	34

90L15DL 2700K - 1800K	Full on 100%	Dimmed to 80%	Dimmed to 70%	Dimmed to 50%	Dimmed to 20%	Dimmed to 10%	Dimmed to 2%
CCT (K)	2700K	2700K	2700K	2700K	2500K	1900K	1800K
Light Output (Lm)	395	316	277	198	79	40	8
Power (W)	15	12	10.5	7.5	3	1.5	0.3
Efficacy (LPW)	36	36	36	36	36	36	36

HALOGEN PROFILE - TRIMLESS

90L11DD 3000K - 1800K	Full on 100%	Dimmed to 80%	Dimmed to 70%	Dimmed to 50%	Dimmed to 20%	Dimmed to 10%	Dimmed to 2%
CCT (K)	3000K	3000K	3000K	3000K	3000K	2000K	1800K
Light Output (Lm)	493	394	345	247	99	49	10
Power (W)	11	8.8	7.7	5.5	2.2	1.1	0.2
Efficacy (LPW)	33	33	33	33	33	33	33

90L15DD 3000K - 1800K	Full on 100%	Dimmed to 80%	Dimmed to 70%	Dimmed to 50%	Dimmed to 20%	Dimmed to 10%	Dimmed to 2%
CCT (K)	3000K	3000K	3000K	3000K	3000K	2000K	1800K
Light Output (Lm)	525	420	368	263	105	53	11
Power (W)	15	12	10.5	7.5	3	1.5	0.3
Efficacy (LPW)	35	35	35	35	35	35	35

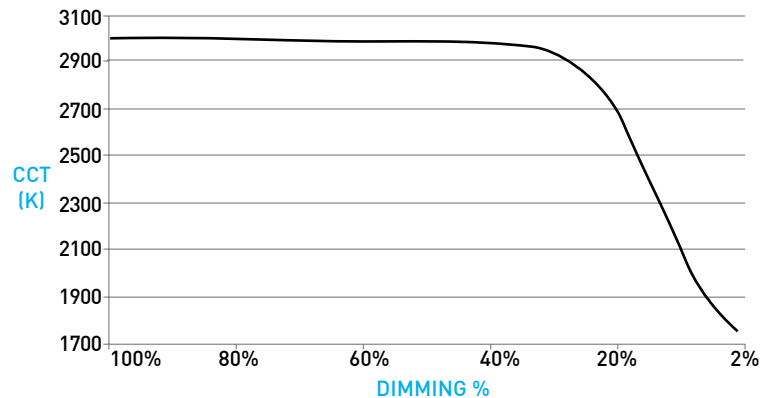
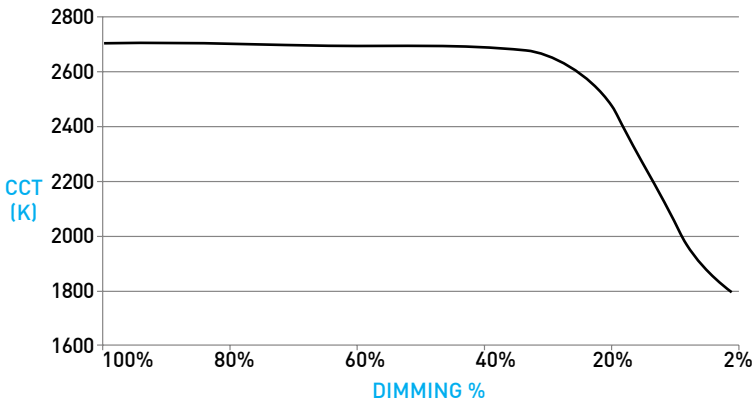

NOTE: LIN-TO-LIN 0-10V PAIRING NOT COMPATIBLE WITH WARM DIM.

# 0 SERIES FIXED REMODEL

## PERFORMANCE - ZERO SIGHTLINE - 3000K - NO LENS

LUMEN PACKAGE	WATTS	20° OPTIC		30° OPTIC		40° OPTIC	
		DLVD	LPW	DLVD	LPW	DLVD	LPW
80S06C	6	234	39	407	68	490	82
80S11C	11	357	32	620	56	745	68
80S15C	15	474	32	824	55	990	66
90S06C	6	203	34	352	59	423	71
90S11C	11	309	28	536	49	644	59
90S15C	15	410	27	712	47	856	57
95S06C	6	146	24	253	42	304	51
95S11C	11	222	20	385	35	463	42
95S15C	15	295	20	512	34	615	41
90L11DL (27K-18K)	11	-	-	-	-	384	37
90L11DD (30K-18K)	11	-	-	-	-	406	37
90L15DL (27K-18K)	15	-	-	-	-	508	34
90L15DD (30K-18K)	15	-	-	-	-	540	36

OUTPUT MULTIPLIER	
CCT	CCT SCALE
2400K	0.89
2700K	0.98
3000K	1.00
3500K	1.09
4000K	1.14

MEDIA LIGHT LOSS MULTIPLIER	
MEDIA	LIGHT LOSS FACTOR
NO LENS	1.00
LENS	0.93

FINISH MULTIPLIER	
CCT	CCT SCALE
WHITE	1.00
BLACK	0.98
SPECULAR BLACK	0.98

## WARM DIM PERFORMANCE - NO LENS - 40° OPTIC

INCANDESCENT PROFILE - ZERO SIGHTLINE

90L11DL 2700K - 1800K	Full on 100%	Dimmed to 80%	Dimmed to 70%	Dimmed to 50%	Dimmed to 20%	Dimmed to 10%	Dimmed to 2%
CCT (K)	2700K	2700K	2700K	2700K	2200K	1900K	1800K
Light Output (Lm)	384	307	269	192	77	38	8
Power (W)	11	8.8	7.7	5.5	2.2	1.1	0.2
Efficacy (LPW)	37	37	37	37	37	37	37
90L15DL 3000K - 1800K	Full on 100%	Dimmed to 80%	Dimmed to 70%	Dimmed to 50%	Dimmed to 20%	Dimmed to 10%	Dimmed to 2%
CCT (K)	2700K	2700K	2700K	2700K	2450K	1900K	1800K
Light Output (Lm)	508	406	356	254	102	51	10
Power (W)	15	12	10.5	7.5	3	1.5	0.3
Efficacy (LPW)	37	37	37	37	37	37	37

HALOGEN PROFILE - ZERO SIGHTLINE

90L11DD 3000K - 1800K	Full on 100%	Dimmed to 80%	Dimmed to 70%	Dimmed to 50%	Dimmed to 20%	Dimmed to 10%	Dimmed to 2%
CCT (K)	3000K	3000K	3000K	3000K	2300K	1850K	1800K
Light Output (Lm)	406	325	284	203	81	41	8
Power (W)	11	8.8	7.7	5.5	2.2	1.1	0.2
Efficacy (LPW)	36	36	36	36	36	36	36
90L15DD 3000K - 1800K	Full on 100%	Dimmed to 80%	Dimmed to 70%	Dimmed to 50%	Dimmed to 20%	Dimmed to 10%	Dimmed to 2%
CCT (K)	3000K	3000K	3000K	3000K	2700K	1900K	1800K
Light Output (Lm)	540	432	378	270	108	54	11
Power (W)	15	12	10.5	7.5	3	1.5	0.3
Efficacy (LPW)	36	36	36	36	36	36	36

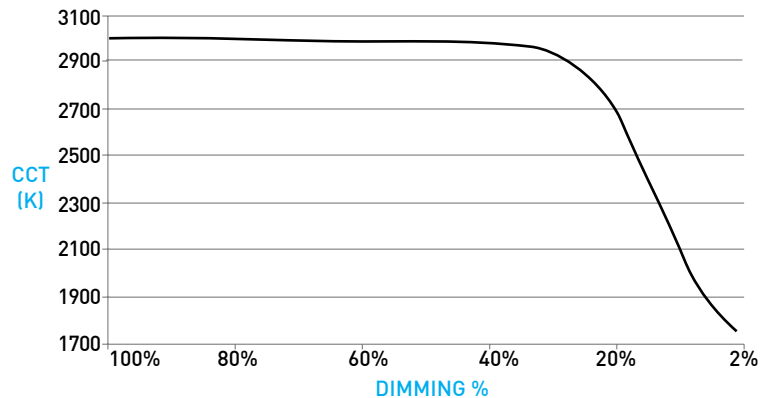
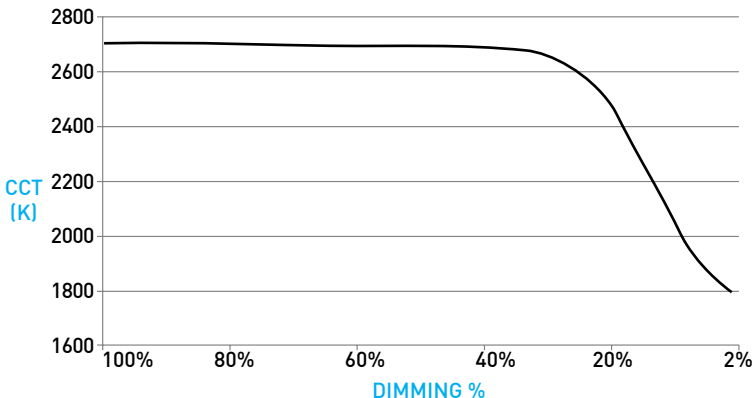

NOTE: LIN-TO-LIN 0-10V PAIRING NOT COMPATIBLE WITH WARM DIM.

# 0 SERIES FIXED REMODEL

## DOWNLIGHT / HOUSING

### A HIGH/LOW WATTAGE REMODEL HOUSING

- For RR installation types.
- IC-rated heatsink, does not have any setback requirements from combustibles and non-combustible materials.
- High wattage housing features 2.00" tall heat sink and is available for 15W packages.
- Low wattage housing features 1.25" tall heat sink and is available for 6W and 11W packages only.

### B LIGHT ENGINE

Robust light engine with optimized optic pairing integrates Reflection, Refraction, and TIR offering 20°, 30°, and 40° beams.

### C REMODEL MOUNTING PLATE

Installs above ceiling, requiring  $\varnothing 6.625"$  cutout. Rectangular design (6.15" x 8.00") allows for installation above ceiling after cutout. Mounting holes align with applique, ensuring secure fixture mounting via factory supplied screws.

### D ZERO-SIGHTLINE / TRIMLESS DRYWALL PROFILE

Installs totally flush with the ceiling with no visible trim. Appliqué includes screws for mounting and has 0.06" plaster stop. Not recommended for stucco applications.

### E ZERO-SIGHTLINE FACEPLATE / BAFFLE

CNC-Milled removable baffle provides 64° glare cutoff. Minimizes aperture glare and conceals view into housing; includes gasket. Exterior faceplate available in powdercoat finishes; interior finish is black powdercoat.

### F TRIMLESS BAFFLE

CNC-Milled baffle provides 61° glare cutoff. Minimizes aperture glare and conceals view into housing; includes gasket. Baffle shape is square for both round and square apertures. Only 0.5" inner aperture is visible after mud-in. **1.7" square ceiling break required for LED/driver servicing.**

### G APPLIQUÉ DETAIL

Appliqué for plaster floating directly to baffle.

## DIMENSIONS / DRAWINGS

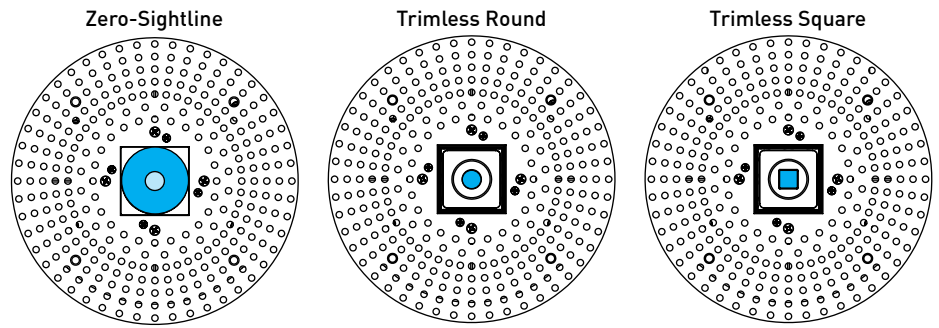
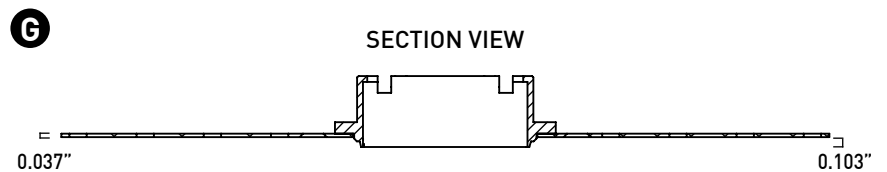
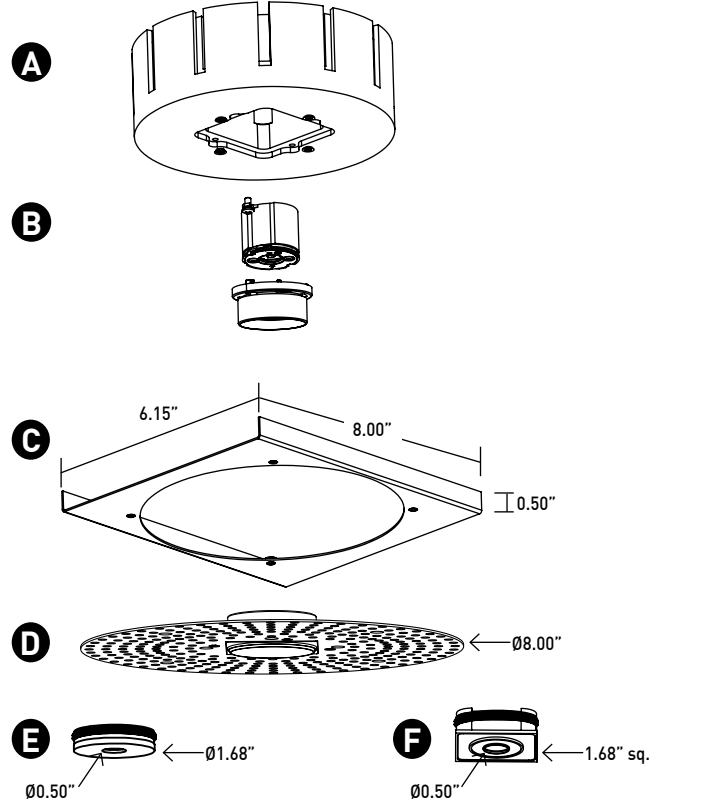
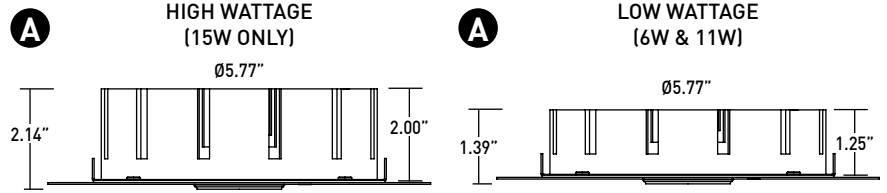

 Visible after mud-in

## REMODEL NOTES

- Do not install Remodel fixtures in environments where ambient temperatures exceed 40°C (104°F).
- Power supply compartment and all splice connections may be serviced from room side.
- Remodel fixtures accommodate ceiling thicknesses between 0.50" and 1.50".

# 0 SERIES FIXED REMODEL

## DOWNLIGHT / HOUSING

### H REMOTE REMODEL APPLICATIONS

- Remote power supply included with "RR" Install Type
- Requires plenum rated Class 2 cable between fixture and remote driver. Cable supplied by others.
- Lever connectors provided for remote power supply connection.
- See page 7 for maximum allowable wiring distances.

### I ATHENA / CASAMBI CONTROL

Controls integrated Remote driver assembly. All equipment is serviceable.

Athena Model Numbers: A-WN-D01-RF-BL & DFC-OEM-DBI

Casambi Model Number: BT-S1E1-5400

### J ATHENA / CASAMBI EM SHUNT

Included with drivers specified as ASR, ADR, CSR, or CDR. One required for each wireless EM fixture, requires class 2 control wiring between fixture and shunt. Features integrated test switch.

Model Number: PS-RMT-SHUNT

## DIMENSIONS / DRAWINGS

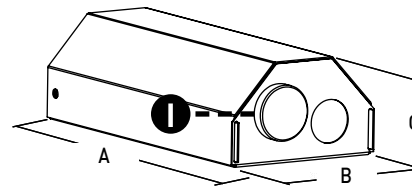
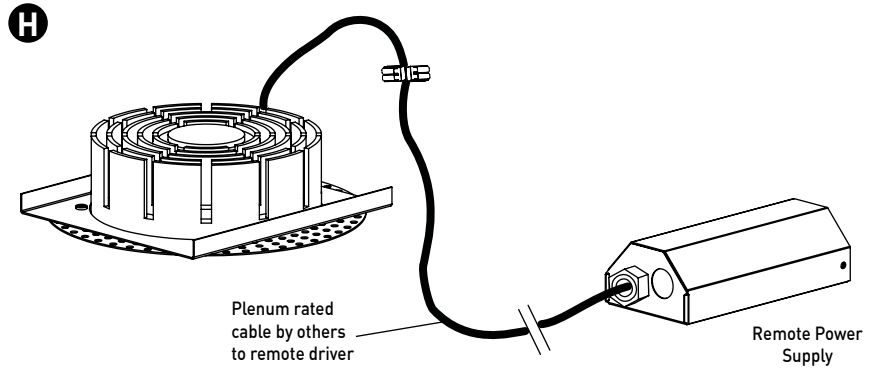

	A	B	C
PHASE / 0-10V / DALI / ECOSYSTEM	6.94"	3.35"	2.00"
ATHENA / CASAMBI	8.10"	5.00"	2.00"

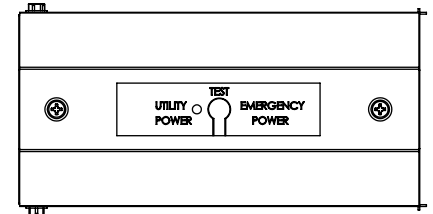
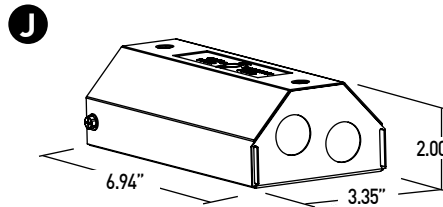

## DISTRIBUTED POWER ACCESSORY

### K HUB

Included with "HUB" driver selection. Allows for multi-fixture power distribution from one remote power supply to a maximum of 6 fixtures. Connectable fixture quantity is specified in fixture part number on page 2. Hub base plate allows for structural mounting and wiring during rough-in. Wiring distances for HUB based on quantity featured in figure K.

Model Number e.g.: HUB2X15WPH1

## DIMENSIONS / DRAWINGS

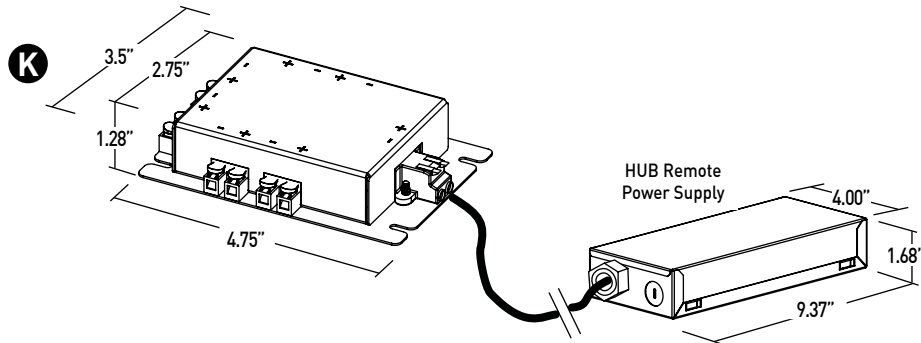

### MAXIMUM ALLOWABLE TOTAL WIRING LENGTH

DRIVER-TO-HUB AWG	HUB-TO-FIXTURE AWG	TOTAL LENGTH
18	18	150'
16	16	200'
14	14	250'
12	18	400'*
12	16	450'*
12	14	500'*

\*Total length requires 250' 12AWG Driver-to-Hub wiring

# 0 SERIES FIXED REMODEL

## TECHNICAL

### CONSTRUCTION

**Downlight:** Painted finishes are granulated powder coat; Alumina finishes are anodized aluminum. Plated finishes are plated.

**Housing:** Forged aluminum heat-sink.

**Remote Power Supply:** 22 Gauge galvanized steel.

**Appliqué:** Aluminum base with 22 Gauge galvanized steel flange.

### STATIC WHITE LED

2-step MacAdam ellipse LED module available in 80+, 90+ and 95+ CRI configurations in color temperatures of 2700K, 3000K, 3500K and 4000K. 3-step MacAdam ellipse LED module available in 90+ CRI configuration in color temperature of 2400K. Average rated lamp life: 50,000 hours. LED and driver assemblies are field-replaceable.

### WARM DIM LED

3-step MacAdam ellipse warm dim LED module available in 90+ CRI configuration 3000K or 2700K at full brightness, warming to 1800K at full dim. Average rated lamp life of 50,000 hours. LED and driver assemblies are field-replaceable.

### POWER SUPPLY PERFORMANCE AND DIMMING INFORMATION

	PHASE	0-10V				ECO	DALI-2	ATHENA		CASAMBI	
Power Supply	PH1	SG5	SN5	EG1	EN1	LP1	ED1	AS1	AD1	CS1	CD1
Minimum °C	-20 °C	-20 °C	-20 °C	-20 °C	-20 °C	0 °C	-20 °C	0 °C	0 °C	-20 °C	-20 °C
Maximum °C	40 °C	40 °C	40 °C	40 °C	40 °C	40 °C	40 °C	40 °C	40 °C	40 °C	40 °C
Dimming %	2.0%	1.0%	1.0%	0.1%	0.1%	0.1%	0.1%	0.1%	0.1%	0.1%	0.1%

Note: For LP1, EG1 and EN1 drivers consult chart on page 8 to confirm appropriate dimming curve for compatibility with selected control.

### MAXIMUM ALLOWABLE REMOTE DRIVER WIRING DISTANCES (SINGLE FIXTURE, SINGLE DRIVER)

DRIVER	WIRE AWG				
	12	14	16	18	20
PH1	285'	180'	113'	71'	45'
LP1	60'	40'	25'	15'	-
EG1, EN1, ED1, SG5, SN5, AS1, CS1, AD1, CD1	-	-	118'	72'	46'

### LISTING

UL1598 standard for IP20 Dry / Damp and IP64 Wet locations. NEMA 410 Compliant.

### DECLARE

LBC Red List Approved.

### BUY AMERICAN ACT

Buy American Act compliant.

### WEIGHT

1.25" Remodel Housing - 3 lbs

2.00" Remodel Housing - 4 lbs

Remote Driver - 1.4 lbs

HUB - 0.73lbs

### LIMITED WARRANTY

Manufacturer's Limited Warranty guarantees product(s) listed to be free from defects in material and workmanship under normal use and service for 1-year. LED and power supplies are warranted to operate with 70% of original flux and remain within a range of 3 duv for a period of 5-years. 10-year Lutron Advantage limited warranty available on Lutron equipped systems. Warranty period begins from the date of shipment by Seller.

### CHANGE LOG

1. 05/06/2025: ADDED WARM DIM AND DISTRIBUTED POWER PRODUCT OFFERINGS

# 0 SERIES FIXED REMODEL

## DIMMING COMPATIBILITY

### LUTRON DRIVER COMPATIBILITY

Power supply <b>LP1</b> Lutron Product Family	Part No.
PowPak Dimming Modules	RMJ-EC032-DV-B
PowPak Dimming Modules	FCJ/FCJS-ECO
Energi Savr Nodes	QSN-1ECO-S
GRAFIK Eye QS control unit Homeworks QS control unit	QSN-2ECO-S
GRAFIK Eye QS control unit Homeworks QS control unit	QSGRJ- _E (wireless) QSGR- _E
Quantum Hub	QP2- _ _ 2C
Quantum Hub	QP2- _ _ 4C
Quantum Hub	QP2- _ _ 6C
Quantum Hub	QP2- _ _ 8C
Homeworks QS power module myRoom Plus power module	LQSE-2ECO-D



### eldoLED DRIVER COMPATIBILITY

Power supply <b>EG1</b> Manufacturer	Family/Model #
Busch-Jaeger	2112U-101
Jung	240-10
Leviton Lighting Controls	IP710-DLX
Lightolier Controls	ZP600FAM120
Merten	5729
Pass & Seymour	CD4FB-W
The Watt Stopper	DCLV1
Synergy	ISD BC
Crestron®	GLX-DIMFLV8
Crestron®	GLXP-DIMFLV8
Crestron®	GLPAC-DIMFLV4-*
Crestron®	GLPAC-DIMFLV8-*
Crestron®	GLPP-DIMFLVEX-PM
Crestron®	GLPP-1DIMFLV2EX-PM
Crestron®	GLPP-1DIMFLV3EX-PM
Crestron®	DIN-A08
Crestron®	DIN-4DIMFLV4
Crestron®	CLS-EXP-DIMFLV
Crestron®	CLCI-1DIMFLV2EX
Power supply <b>EN1</b> Manufacturer	Family/Model #
Lutron Electronics	Nova T® - NTFTV
Lutron Electronics	Diva® - DDTV
Lutron Electronics	Nova® - NFTV
Lutron Electronics	GrafixEye® GRX-TVI w GRX3503
Lutron Electronics	Energy Savr Node™ - QSN-4T16-S
Lutron Electronics	TVM2 Module
Sensor Switch	nIO EZ
ABB	SD/S 2.16.1

### ANALOG DRIVERS AND DIMMERS

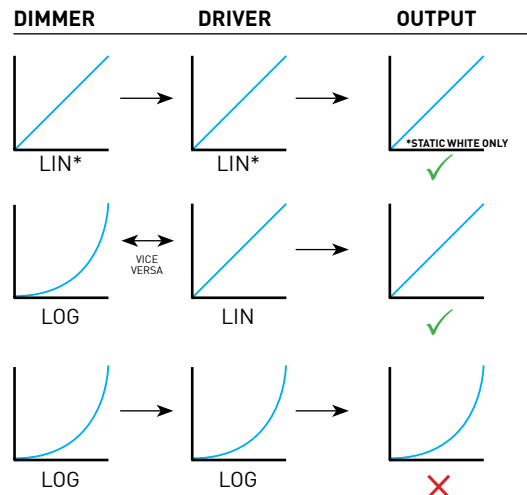

LIN = LINEAR  
 LOG = LOGARITHMIC  
 \*LIN-TO-LIN NOT COMPATIBLE FOR WARM-DIM