

1 SERIES

FIXED IC HOUSING

TRIMLESS

- Max output of 971Lm at 80+ CRI, 839Lm at 90+ CRI
- Available with trimless and zero sightline baffles, featuring 1" and 1.6" apertures
- Expanded baffles feature UGR value of <7
- Available for Zero Sightline Millwork
- Available for remodel and flange overly applications. See separate spec sheet

PROJECT NAME:	TYPE:
---------------	-------

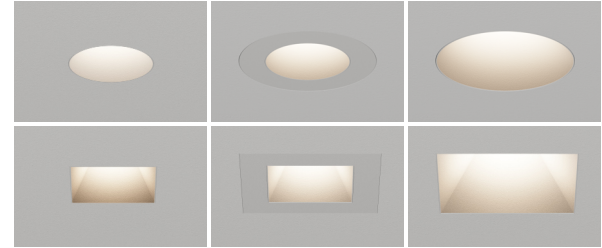

ORDERING INFORMATION - FIXTURE

TITLE 24 COMPLIANT JA8-2022 COMPLIANCE INDICATED BY SHADING

TRIM	RATING	TYPE	BAFFLE & MOUNTING	EXTERIOR FINISH	INTERIOR FINISH	CRI	WATTAGE	CCT	OPTIC (UGR)	MEDIA	INSTALL TYPE	CEILING THICKNESS	DRIVER
		F										1	
1RP 1SP 1RE 1SE 1RS 1SS	1 IP20 Dry/Damp 2 IP64 Wet	Fixed	Trimless	TRIMLESS TG Trimless Gypsum* *(Required for "T" baffle) TM Trimless Millwork* *(1RE/1SE/1RS/1SS only. Required for trimless millwork)	POWDERCOAT WH White AG Satin Silver AU Cashmere Gold AB Architectural Bronze BB Burnt Bronze BK Black SB Specular Black PR Primer CF Custom Finish* *(Consult Factory) ALUMINA *Brushed finishes only available for round baffles 01 Brushed Obsidian* 02 Matte Obsidian 03 Brushed Dark Patinated Bronze* 04 Matte Aged Aluminum 05 Brushed Aged Aluminum 06 Matte Aged Aluminum 07 Brushed Cast Brass* 08 Matte Cast Brass 09 Brushed Light Patinated Bronze 10 Matte Light Patinated Bronze	80S 80+ CRI 90S 90+ CRI 95S 95+ CRI 90L 90+ CRI	STATIC WHITE 1RE/1SE 06C 6W, 504 Lm 11C 11W, 768 Lm 15C 15W, 970 Lm WARM DIM 1RE/1SE 11D 11W 15D 15W Incandescent Profile 11D - 367 Lm 15D - 490 Lm Halogen Profile 11D - 389 Lm 15D - 520 Lm	24 2400K* *(90 CRI only) 27 2700K 30 3000K 35 3500K 40 4000K WL 2700K-1800K WD 3000K-1800K	20 20° 30 30° 40 40° 40 40°	NL No Lens* *(Not available for wet location) 01 Clear Media 02 Soft Focus Media* *(Required for 20° Optic) 03 Warm Dim Diffusion Media* *(Required for Warm Dim)	INTEGRAL DRIVER IC IC AT IC, Airtight CP CCEA Chicago Plenum REMOTE DRIVER IR IC, Remote AR IC, Airtight, Remote CR CCEA Chicago Plenum, Remote	1 0.50" - 1.50"	INTEGRAL / REMOTE PH1 Forward / Reverse Phase, 2%, 120V SG3 eldoLED, ECOdrive 1%, 0-10V, LOG, 120V-277V EG1 eldoLED, SOLOdrive 0.1% 0-10V, LOG, 120V-277V ED1 eldoLED, SOLOdrive 0.1% DALI-2, LOG, 120V-277V AS1 Athena Control eldoLED, SOLOdrive 0.1%, 120V-277V* *(Includes Athena Node. Extended lead time, consult factory) REMOTE LP1 Lutron, Hi-Lume Premier Ecosystem 0.1% Fade to Black, 120V or 277V LX1 eldoLED, SOLOdrive 0.1% DMX, LOG, 120V-277V HUB Separate Remote Power Supply and Distribution Hub, Powers up to 6 Fixtures* *(Requires further specification on page 2) BUD Combined Remote Power Distribution, Powers up to 6 Fixtures* *(Requires further specification on page 2) LOW VOLTAGE SYSTEM LVS Low Voltage System* *(See page 8 for specification information) CONSULT FOR 0-10V LINEAR OR CASAMBI DRIVER OPTIONS

PART NUMBER NOTES

- Fixture ships as e.g., 1RE2FTTGAU90S15C3540NLIC1SG3
- Housing, driver, trim, and applique ship as one unit



1 SERIES FIXED IC HOUSING TRIMLESS

DISTRIBUTED POWER ACCESSORIES

CONFIGURATION - REQUIRED FOR 'HUB' AND 'BUD' DRIVER SPECIFICATION

ASSEMBLY	QTY	WATTAGE	REMOTE DRIVER
HUB Separate Remote Power Supply and Distribution Hub	2X 2 Fixtures 3X 3 Fixtures 4X 4 Fixtures 5X 5 Fixtures 6X 6 Fixtures	06W 6 Watts 11W 11 Watts 15W 15 Watts	PH1 Forward/Reverse Phase, 2%, 120V SG5 eldoLED, ECOdrive 1%, 0-10V, LOG, 120V-277V EG1 eldoLED, SOL0drive 0.1% 0-10V, LOG, 120V-277V ED1 eldoLED, SOL0drive 0.1% DALI-2, LOG, 120V-277V AS1 Athena Control, eldoLED, SOL0drive, 0.1%, 120V-277V* <small>*Includes Athena Node. Extended lead time, consult factory)</small>
BUD Combined Remote Power Distribution			

COMPATIBILITY BY DRIVER TYPE AND QUANTITY

DRIVER	HUB2X			HUB3X			HUB4X			HUB5X			HUB6X		
	06W	11W	15W	06W	11W	15W	06W	11W	15W	06W	11W	15W	06W	11W	15W
PH1	✓	✓	✓	✓	✓	✓	✓	✓	✓	✓	✓	✓	✓	✓	✓
SG5	✓	✓	✓	✓	✓	✓	✓	✓	✓	✓	✓	✓	✓	✓	✓
EG1/ED1	✓	✓	✓	✓	✓	✓	✓	✓	✓	✓	✓	✓	✓	✓	✓
AS1	✓	✓	✓	✓	✓	✓	✓	✓	✓	✓	✓	✓	✓	✓	✓

PART NUMBER NOTES

- Hub and Bud assemblies are ordered as separate line item from fixtures. See pages 6-7 for additional details.

FINISHES

POWDERCOAT FINISHES

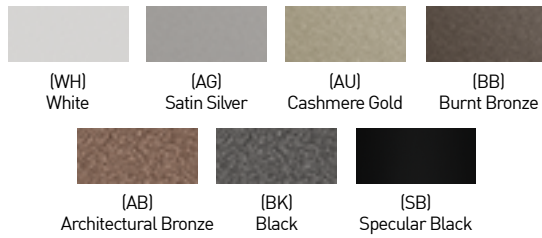

ALUMINA FINISHES BY LUCIFER LIGHTING™



ACCESSORIES

REPLACEMENT OPTICS

Interchangeable optics accessible through fixture aperture with baffle removal.

STATIC WHITE

- RO-17-A-20** 20° optic
- RO-17-A-30** 30° optic
- RO-17-A-40** 40° optic

WARM DIM

- RO-17-A-40-W** 40° optic

REPLACEMENT BAFFLE ASSEMBLY (INCLUDES MEDIA)

ASSEMBLY	SHAPE	RATING	TYPE	BAFFLE	EXTERIOR FINISH	INTERIOR FINISH	MEDIA
RBA			F				
REPLACEMENT BAFFLE ASSEMBLY	1RP 1" Round	1 IP20 Dry/Damp 2 IP64 Wet	F Fixed	T Trimless	TG Trimless Gypsum TM Trimless Millwork	WH White AG Satin Silver AU Cashmere Gold BB Burnt Bronze BK Black PR Primer CF Custom Finish* <small>*[Consult Factory]</small> <small>**See page 1 for Alumina finish options</small>	NL No Lens* <small>*[Not available for wet location]</small> 01 Clear Glass Media 02 Soft Focus Media* <small>*[Required for 20° Optic]</small> 03 Warm Dim Diffusion Media* <small>*[Required for Warm Dim]</small>
	1SE 1.6" Square Expanded Deep Regress			G Zero Sightline Gypsum* <small>(1RP/1SP Only)</small> G Zero Sightline Millwork* <small>(1RP/1SP Only)</small>	AB Arch. Bronze BB Burnt Bronze BK Black PR Primer CF Custom Finish* <small>*[Consult Factory]</small> <small>**See page 1 for Alumina finish options</small>		
	1RS 1.6" Round Expanded						
	1SS 1.6" Square Expanded						

REPLACEMENT INSTALLATION TOOLS

One included with every six fixtures.

- 01S-TOOL-BAFFLE-REMOVAL** Allows for baffle removal
- 01S-TOOL-ENGINE-INST-REMOVAL** Allows for installation of LED module
- 01S-TOOL-ENGINE-BAFFLE-COMBO** Includes both baffle removal tool and LED installation tool

HANGER BAR EXTENDER KIT

Extends hanger bars from 24.0" to 46.0" maximum.

- FRX-HBE-46** Extender, Hanger Bar

EMERGENCY LIGHTING - REMOTE MOUNT ONLY

During disruption of main power, emergency battery inverter provides temporary 120V or 277V to fixture.

- EMB-S-25-120/277-LEDX** 25 watt max capacity, 120 or 277 VAC 60Hz, Non-Dimmable
- EMB-S-100-120-LEDX** 100 watt max capacity, 120 VAC 60Hz, 0-10V Dimmable
- EMB-S-100-277-LEDX** 100 watt max capacity, 277 VAC 60Hz, 0-10V Dimmable
- EMB-S-250-120/277-LEDX** 250 watt max capacity, 120 or 277 VAC 60Hz, 0-10V Dimmable

***CONSULT FACTORY FOR USE WITH WIRELESS CONTROLS.**

1 SERIES FIXED IC HOUSING TRIMLESS

PERFORMANCE - 1RE / 1SE - 3000K

LUMEN PACKAGE	WATTS	20° OPTIC Soft Focus Media		30° OPTIC No Lens		40° OPTIC No Lens	
		DLVD	LPW	DLVD	LPW	DLVD	LPW
80S06C	6	222	37	393	65	504	84
80S11C	11	338	31	598	54	768	70
80S15C	15	449	30	795	53	970	65
90S06C	6	192	32	340	57	436	73
90S11C	11	292	27	517	47	664	60
90S15C	15	388	26	687	46	839	56
95S06C	6	138	23	244	41	313	52
95S11C	11	210	19	372	34	477	43
95S15C	15	279	19	494	33	611	41
90L11DL (27K-18K)	11	-	-	-	-	370	34
90L11DD (30K-18K)	11	-	-	-	-	392	36
90L15DL (27K-18K)	15	-	-	-	-	490	33
90L15DD (30K-18K)	15	-	-	-	-	520	35

OPTIC	LIGHT LOSS FACTOR
20°	1.00
30°	0.98
40°	0.95

MEDIA	LIGHT LOSS FACTOR
NO LENS	1.00
LENS	0.93

CCT	CCT SCALE
2400K	0.89
2700K	0.98
3000K	1.00
3500K	1.09
4000K	1.14

CCT	CCT SCALE
WHITE	1.00
BLACK	0.98
SPECULAR BLACK	0.98

TITLE 24 JA8-2022 INDICATED BY SHADING

UNIFIED GLARE RATING

20° OPTIC	30° OPTIC	40° OPTIC
<7	<7	<7

WARM DIM PERFORMANCE - 1RE / 1SE - 40° OPTIC

INCANDESCENT PROFILE - TRIMLESS

90L11DL 2700K - 1800K	Full on 100%	Dimmed to 80%	Dimmed to 70%	Dimmed to 50%	Dimmed to 20%	Dimmed to 10%	Dimmed to 2%
CCT (K)	2700K	2700K	2700K	2700K	2500K	1900K	1800K
Light Output (Lm)	370	296	259	185	74	37	7
Power (W)	11	8.8	7.7	5.5	2.2	1.1	0.2
Efficacy (LPW)	33	33	33	33	33	33	33
90L15DL 2700K - 1800K	Full on 100%	Dimmed to 80%	Dimmed to 70%	Dimmed to 50%	Dimmed to 20%	Dimmed to 10%	Dimmed to 2%
CCT (K)	2700K	2700K	2700K	2700K	2500K	1900K	1800K
Light Output (Lm)	490	392	343	245	98	49	10
Power (W)	15	12	10.5	7.5	3	1.5	0.3
Efficacy (LPW)	32	32	32	32	32	32	32

HALOGEN PROFILE - TRIMLESS

90L11DD 3000K - 1800K	Full on 100%	Dimmed to 80%	Dimmed to 70%	Dimmed to 50%	Dimmed to 20%	Dimmed to 10%	Dimmed to 2%
CCT (K)	3000K	3000K	3000K	3000K	3000K	2000K	1800K
Light Output (Lm)	392	314	274	196	78	39	8
Power (W)	11	8.8	7.7	5.5	2.2	1.1	0.2
Efficacy (LPW)	33	33	33	33	33	33	33
90L15DD 3000K - 1800K	Full on 100%	Dimmed to 80%	Dimmed to 70%	Dimmed to 50%	Dimmed to 20%	Dimmed to 10%	Dimmed to 2%
CCT (K)	3000K	3000K	3000K	3000K	3000K	2000K	1800K
Light Output (Lm)	520	416	364	260	104	52	10
Power (W)	15	12	10.5	7.5	3	1.5	0.3
Efficacy (LPW)	35	35	35	35	35	35	35

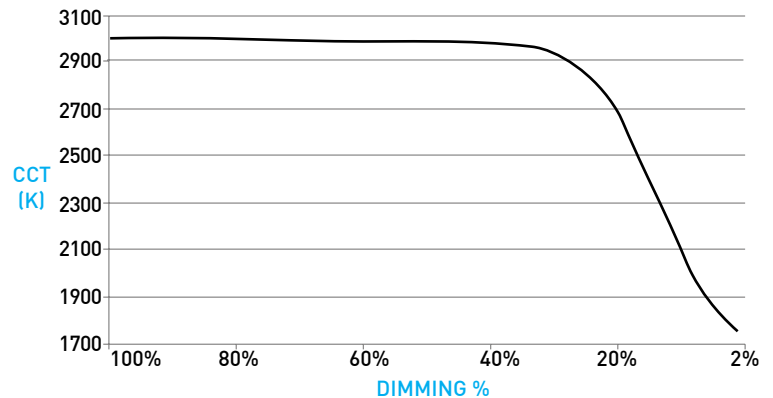
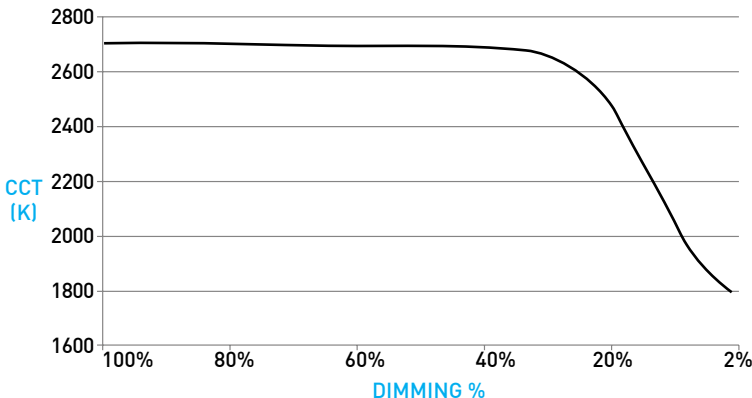

NOTE: LIN-TO-LIN 0-10V PAIRING NOT COMPATIBLE WITH WARM DIM.

1 SERIES FIXED IC HOUSING TRIMLESS

DOWNLIGHT / HOUSING

A IC HOUSING

- For IC ceilings, also suitable for NC applications.
- No setback from polycell spray foam insulation having max R-Value of 60 on all sides and top of housing.

B LIGHT ENGINE

Robust light engine with optimized optic pairing integrates Reflection, Refraction, and TIR offering 20°, 30°, and 40° beams.

C ZERO-SIGHTLINE / TRIMLESS DRYWALL PROFILE

Installs totally flush with the ceiling with no visible trim. Appliqué includes screws for mounting and has 0.06" plaster stop. Not recommended for stucco applications.

D TRIMLESS MILLWORK / ZERO SIGHTLINE MILLWORK

Provided for Trimless Millwork (Type "M") installations; includes (1) 1/16" spacer and (5) 1/8" spacers.

E 1.6" DEEP REGRESS BAFFLE

CNC-Milled removable baffle provides 46° glare cutoff. Minimizes aperture glare and conceals view into housing; includes gasket. No exterior finish, interior finish available in powdercoat and alumina finishes.

F 1.6" BAFFLE

CNC-Milled removable baffle provides 45° glare cutoff. Minimizes aperture glare and conceals view into housing; includes gasket. No exterior finish, interior finish available in powdercoat and alumina finishes.

G 1.0" ZERO-SIGHTLINE BAFFLE

CNC-Milled removable baffle provides 45° glare cutoff. Minimizes aperture glare and conceals view into housing; includes gasket. Exterior faceplate available in powdercoat and alumina finishes; interior finish available in powdercoat and alumina finishes.

H 1.0" INSERT / TRIMLESS BAFFLE

CNC-Milled baffle provides 45° glare cutoff. Minimizes aperture glare and conceals view into housing; includes gasket. No exterior finish, interior finish available in powdercoat and alumina finishes.

Note: Trimless baffle requires 1.6" square ceiling break for LED / Driver servicing.

DIMENSIONS / DRAWINGS

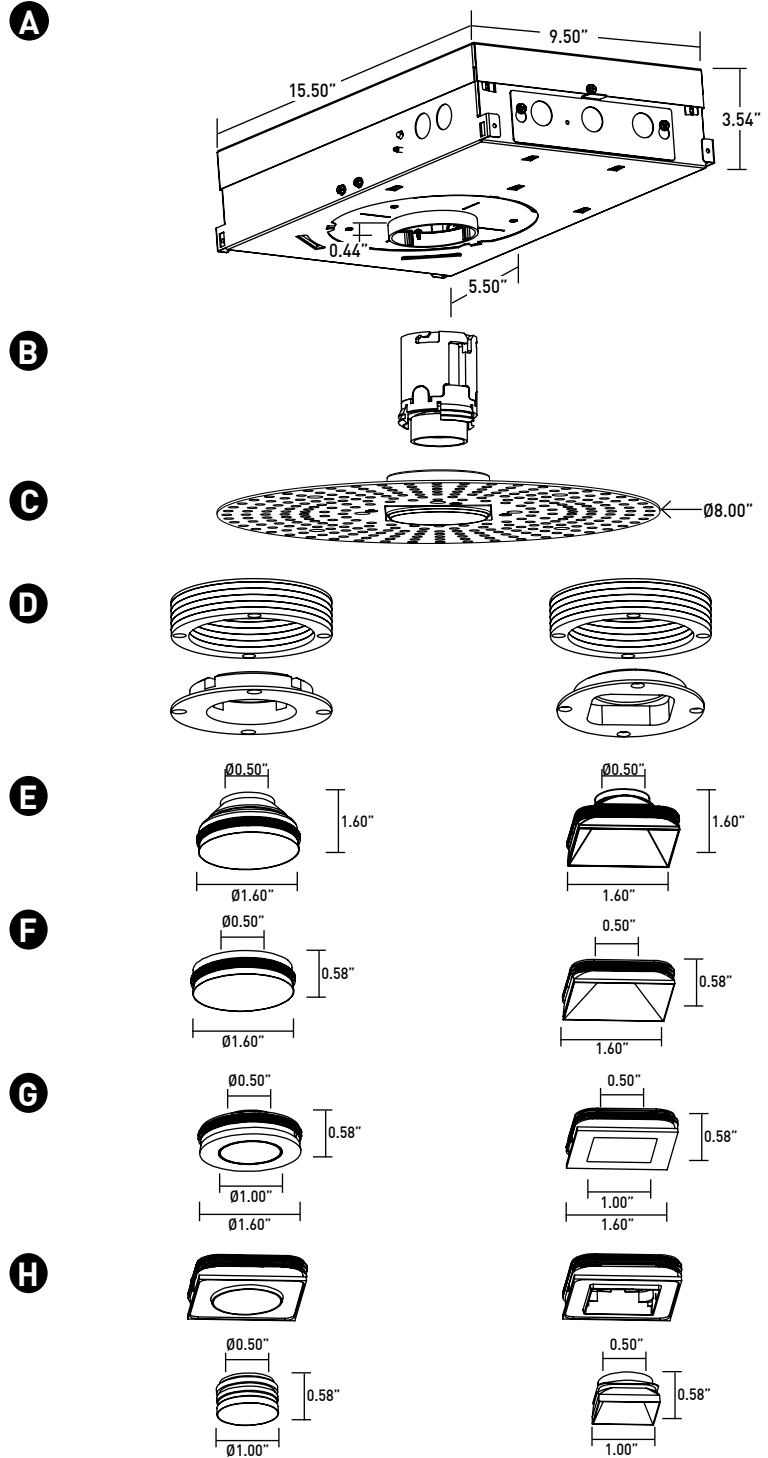

PARTS CONFIGURATION MATRIX

CONFIGURATION	PARTS
1.6" TRIMLESS GYPSUM	C, E -OR- F
1.6" TRIMLESS MILLWORK	D, E -OR- F
1.0" ZERO-SIGHTLINE GYPSUM	C, G
1.0" ZERO-SIGHTLINE MILLWORK	D, G
1.0" TRIMLESS GYPSUM	C, H

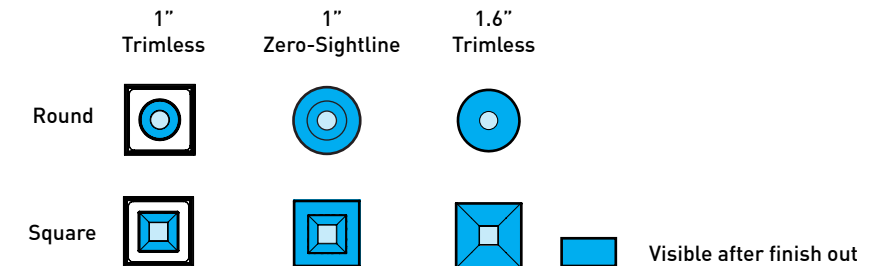

1 SERIES FIXED IC HOUSING TRIMLESS

DOWNLIGHT / HOUSING

- I APPLIQUÉ DETAIL**
Appliqué for plaster floating directly to baffle.
- J TRIMLESS MILLWORK**
Installs totally flush with the ceiling with no visible trim. Requires the spacers and adaptor specified with "M" installation type.
- K REMOTE POWER SUPPLY**
Provided with install Types "IR", "NR", "AR" and "CR". Remote power supply provides additional driver options. See page 9 for maximum allowable secondary run lengths between PS-RMT and fixture. Must be installed in an accessible location.
- L ATHENA / CASAMBI CONTROL**
Controls integrated Remote driver assembly. All equipment is serviceable.

Athena Model Numbers: A-WN-D01-RF-BL & DFC-OEM-DBI

Casambi Model Number: BT-S1E1-5400

DIMENSIONS / DRAWINGS

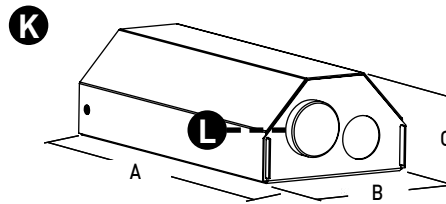
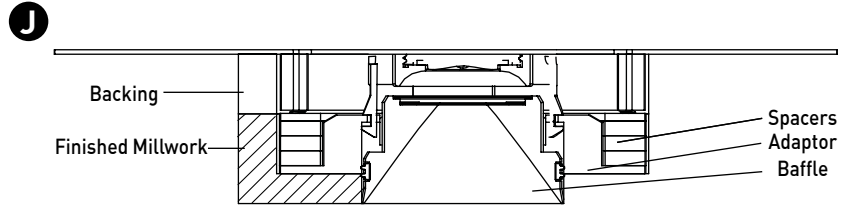
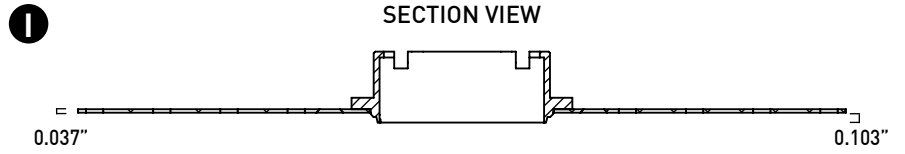

	A	B	C
PHASE / 0-10V / DALI / ECOSYSTEM / DMX	6.94"	3.35"	2.00"
ATHENA / CASAMBI	8.10"	5.00"	2.00"

RECESSED HOUSING NOTES

- Power supply compartment and all splice connections may be serviced from room side.
- Consult factory for spacing requirements for any installations exceeding R-Value 60.
- Hanger bars extend from 14.0" to 24.0", but may be field cut to accommodate narrow stud spacing. Can be extended up to 46" maximum with FRX-HBE-46 kit.
- Hanger bars and brackets add 4.00" max to the overall dimension, but are exclusive of the setback requirements.
- Housings for both round and square trims feature a round aperture housing collar that rotates up to 90 degrees for fixture alignment. Housing collars accommodate ceiling thicknesses between 0.50" and 1.50".

1 SERIES FIXED IC HOUSING TRIMLESS

DISTRIBUTED POWER ACCESSORY

M HUB (SEPARATE COMPONENTS)

Included with "HUB" driver selection. Allows for multi-fixture power distribution from one remote power supply to a maximum of 6 fixtures. Connectable fixture quantity is specified in fixture part number on page 2. Hub base plate allows for structural mounting and wiring during rough-in. Wiring distances for HUB based on quantity featured in figure M.

Model Number e.g.: HUB2X15W-PH1

N BUD (COMBINED ASSEMBLY)

Included with "BUD" driver selection. Allows for multi-fixture power distribution from combined remote power supply to a maximum of 6 fixtures. Connectable fixture quantity is specified in fixture part number on page 2. BUD base plate allows for structural mounting and wiring during rough-in. Wiring distances for BUD based on quantity featured in figure N.

Model Number e.g.: BUD4X11W-SG5

DIMENSIONS / DRAWINGS

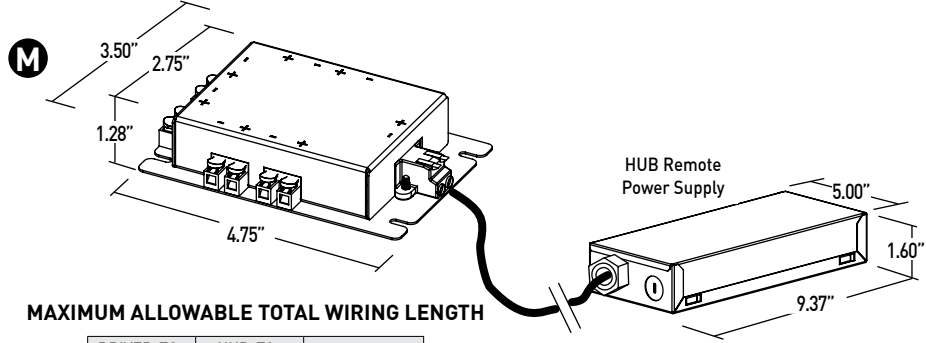

MAXIMUM ALLOWABLE TOTAL WIRING LENGTH

DRIVER-TO-HUB AWG	HUB-TO-FIXTURE AWG	TOTAL LENGTH
18	18	150'
16	16	200'
14	14	250'
12	18	400'*
12	16	450'*
12	14	500'*

*Total length requires 250' 12AWG Driver-to-Hub wiring

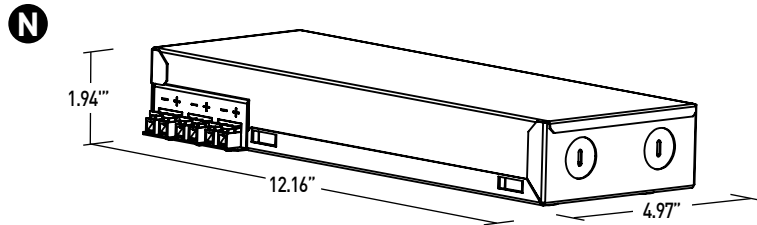

MAXIMUM ALLOWABLE TOTAL WIRING LENGTH

BUD-TO-FIXTURE AWG	TOTAL LENGTH
18	150'
16	200'
14	250'

1 SERIES FIXED IC HOUSING TRIMLESS

HUB WIRING DETAILS

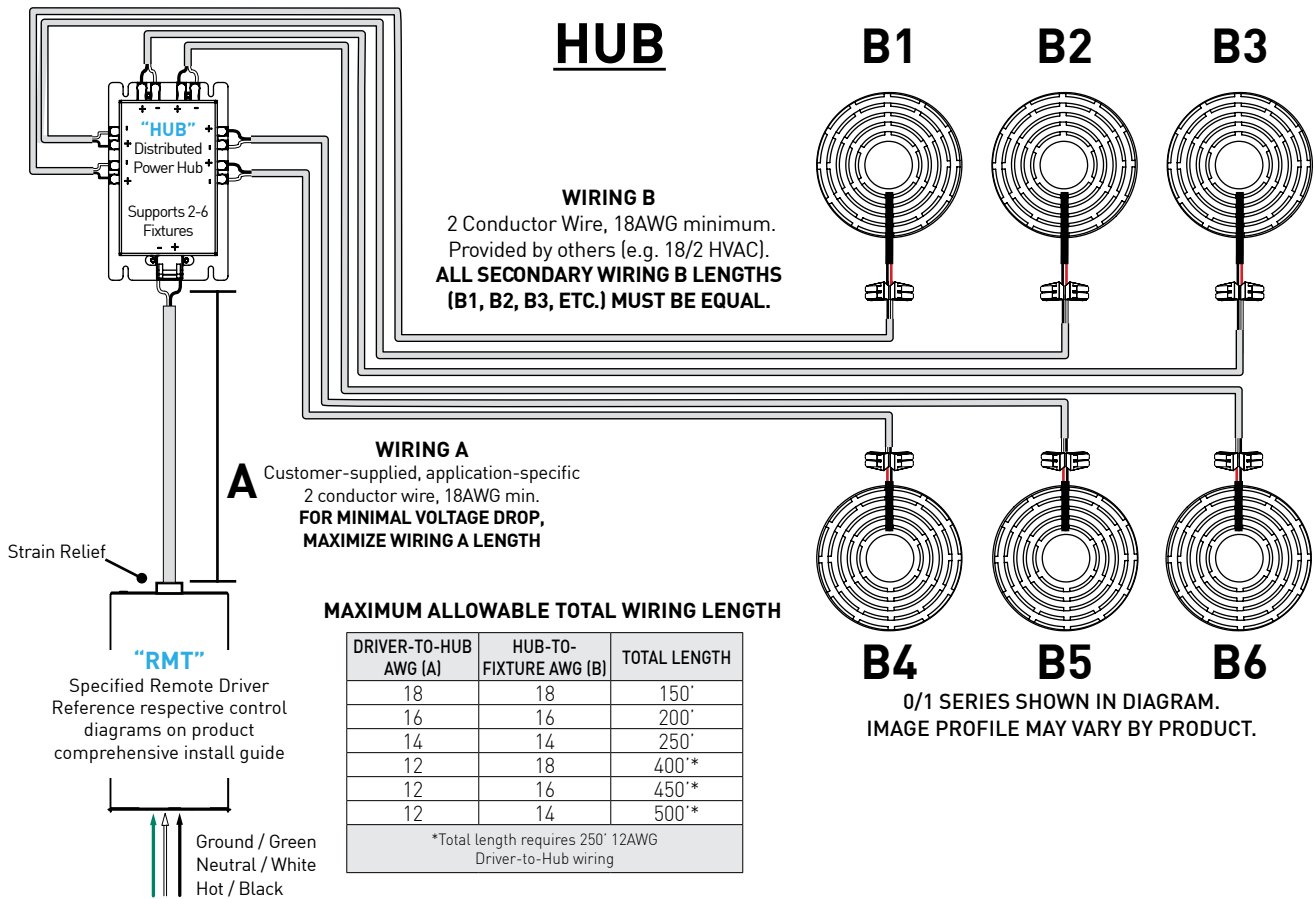

BUD WIRING DETAILS

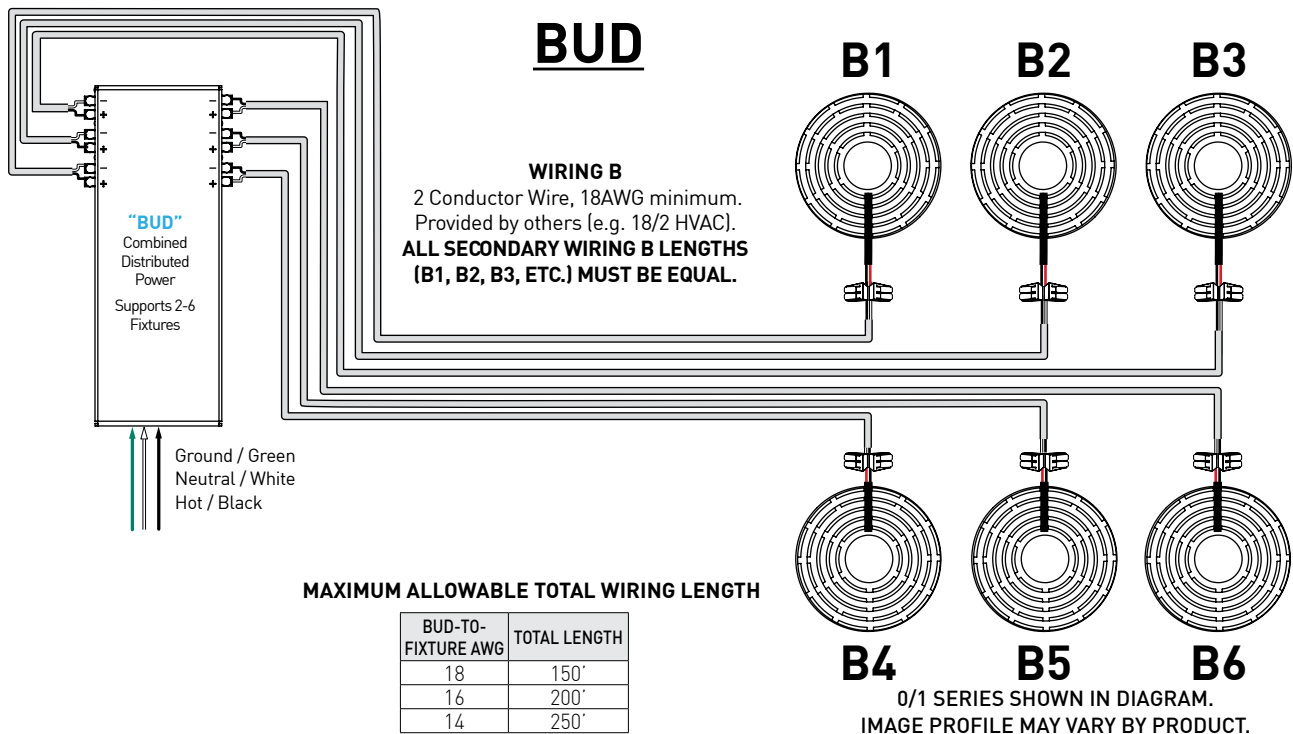

1 SERIES FIXED IC HOUSING TRIMLESS

LOW VOLTAGE SYSTEM (LVS) SPECIFICATION NOTES

- Customers are responsible for ensuring power supply drive current is set to correct values shown below in the drive current specifics section.
- Customers must ensure voltage range of the proposed power supply encompasses the fixtures complete Vf range, both maximum and minimum, and can be set to the required mA drive current. If assistance is required contact your manufacturers representative or the factory.
- Lucifer Lighting is not responsible for confirming dimming compatability between power supplies and control systems / dimmers.
- Lucifer Lighting will not ship fixtures with a power supply supplied by others inside the fixture.
- Consult power supply manufacturer for maximum remote wiring distances.
- Housing and Fixture feature 18 AWG wiring.
- Wiring connections are made in the splicing compartment using customer supplied connectors, ex. wire nuts, push-in connectors, or terminal blocks.
- LVS Housings and Fixtures supplied by Lucifer Lighing are UL 2108 Listed.

DRIVE CURRENT SPECIFICS

	80S / 90S / 95S			90L	
	06C	11C	15C	11D	15D
Minimum Vf	31	31	31	33	33
Maximum Vf	37	37	37	38	38
Current mA	150	250	350	250	350
Wattage W	5.0	8.5	11.8	8.9	12.5

1 SERIES FIXED IC HOUSING TRIMLESS

TECHNICAL

CONSTRUCTION

Downlight: Painted finishes are granulated powder coat; Alumina finishes are anodized aluminum.

Housing: Aluminum and 22 Gauge galvanized steel. Forged aluminum heat-sink.

Remote Power Supply: 22 Gauge galvanized steel.

Appliqué: Aluminum base with 22 Gauge galvanized steel flange.

STATIC WHITE LED

2-step MacAdam ellipse LED module available in 80+, 90+ and 95+ CRI configurations in color temperatures of 2700K, 3000K, 3500K and 4000K. 3-step MacAdam ellipse LED module available in 90+ CRI configuration in color temperature of 2400K. Average rated lamp life: 50,000 hours. LED and driver assemblies are field-replaceable.

WARM DIM LED

3-step MacAdam ellipse warm dim LED module available in 90+ CRI configuration 3000K or 2700K at full brightness, warming to 1800K at full dim. Average rated lamp life of 50,000 hours. LED and driver assemblies are field-replaceable.

POWER SUPPLY PERFORMANCE AND DIMMING INFORMATION

	PHASE		0-10V		ECO	DALI-2	DMX	ATHENA
Power Supply	PH1	SG3	EG1	LP1	ED1	LX1	AS1	
Minimum °C	-20 °C	-20 °C	-20 °C	0 °C	-20 °C	-20 °C	0 °C	
Maximum °C	40 °C	40 °C	40 °C	40 °C	40 °C	40 °C	40 °C	
Dimming %	2.0%	1.0%	0.1%	0.1%	0.1%	0.1%	0.1%	

Note: For PH1, LP1, SG3 and EG1 drivers consult chart on page 10 to confirm appropriate dimming curve for compatibility with selected control.

MAXIMUM ALLOWABLE REMOTE DRIVER WIRING DISTANCES

DRIVER	WIRE AWG				
	12	14	16	18	20
PH1	285'	180'	113'	71'	45'
LP1	60'	40'	25'	15'	-
EG1, ED1, SG3, AS1, AD1, LX1	-	-	118'	72'	46'

LISTING

Fixtures listed to UL 1598 for Dry / Damp and Wet Locations, and are NEMA 410 compliant.

LVS designated fixtures are listed to UL 2108.

Install Types AT & AR are Title 24 JA8-2022 compliant.

Install Types CP & CR are CCEA certified.

BUY AMERICAN ACT / BUILD AMERICA BUT AMERICA

Buy American Act (BAA) and Build America Buy America (BABA) compliant.

WEIGHT

Housing with Integral Driver - 7 lbs max

Remote Driver - 1.4 lbs

LIMITED WARRANTY

Manufacturer's Limited Warranty guarantees product(s) listed to be free from defects in material and workmanship under normal use and service for 1-year. LED and power supplies are warranted to operate with 70% of original flux and remain within a range of 3 duv for a period of 5-years.

10-year Lutron Advantage limited warranty available on Lutron equipped systems. Warranty period begins from the date of shipment by Seller.

[Consult website for full warranty terms and conditions.](#)

CHANGE LOG

- 05/06/2025: ADDED WARM DIM AND DISTRIBUTED POWER PRODUCT OFFERINGS.
- 12/09/2025: ADDED LVS OFFERING.
- 02/26/2026: ADDED BUD POWER SUPPLY
- 06/23/2026: ADDED DMX POWER SUPPLY
- 06/23/2026: DISCONTINUED LINEAR 0-10V AND CASAMBI DRIVER OFFERINGS.



1 SERIES FIXED IC HOUSING TRIMLESS

DIMMING COMPATIBILITY

PHILIPS DRIVER COMPATIBILITY

Power supply PH1 Manufacturer	Family/Model #
Lutron Electronics	DV-600P
Lutron Electronics	DVELV-303P
Lutron Electronics	NTELV-600
Lutron Electronics	MAELV-600
Lutron Electronics	SELV-300P
Lutron Electronics	DVLV-600P
Lutron Electronics	NFTU-5A
Lutron Electronics	CTCL-153P
Lutron Electronics	GL-600H
Lutron Electronics	S-600P
Lutron Electronics	PHPM

LUTRON DRIVER COMPATIBILITY

Power supply LP1 Lutron Product Family	Part No.
PowPak Dimming Modules	RMJ-EC032-DV-B
PowPak Dimming Modules	FCJ/FCJS-ECO
Energi Savr Nodes	QSN-1ECO-S
GRAFIK Eye QS control unit Homeworks QS control unit	QSN-2ECO-S
GRAFIK Eye QS control unit Homeworks QS control unit	QSGRJ- _E (wireless) QSGR- _E
Quantum Hub	QP2-__ _2C
Quantum Hub	QP2-__ _4C
Quantum Hub	QP2-__ _6C
Quantum Hub	QP2-__ _8C
Homeworks QS power module myRoom Plus power module	LQSE-2ECO-D



Power supply EG1 / SG3 Manufacturer	Family/Model #
Busch-Jaeger	2112U-101
Jung	240-10
Leviton Lighting Controls	IP710-DLX
Lightolier Controls	ZP600FAM120
Merten	5729
Pass & Seymour	CD4FB-W
The Watt Stopper	DCLV1
Synergy	ISD BC
Crestron®	GLX-DIMFLV8
Crestron®	GLXP-DIMFLV8
Crestron®	GLPAC-DIMFLV4-*
Crestron®	GLPAC-DIMFLV8-*
Crestron®	GLPP-DIMFLVEX-PM
Crestron®	GLPP-1DIMFLV2EX-PM
Crestron®	GLPP-1DIMFLV3EX-PM
Crestron®	DIN-A08
Crestron®	DIN-4DIMFLV4
Crestron®	CLS-EXP-DIMFLV
Crestron®	CLCI-1DIMFLV2EX

ANALOG DRIVERS AND DIMMERS

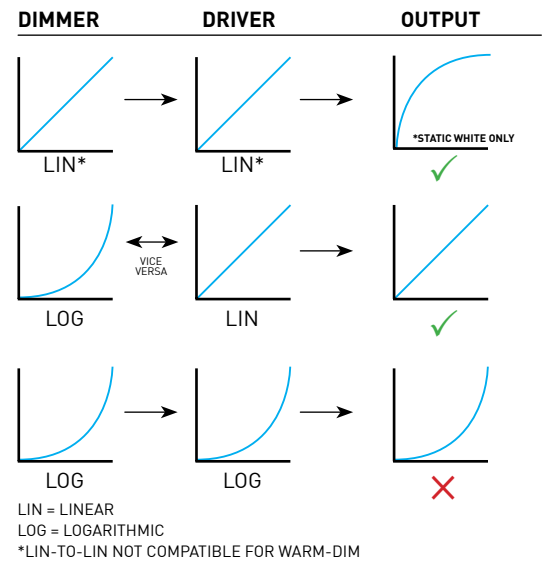

DMX DIMMING INFORMATION

- Fixtures do not ship pre-addressed; fixture addressing is completed by the installer or a commissioning contractor via RDM.
- All fixtures are RDM compatible.
- DMX Channel Count:
Static White / Warm Dim: 1
Tunable White: 2; Channel 1 Warm and Channel 2 Cool
- DMX run termination provided by others.
- DMX Connection Type: Pigtail
- DMX Color Scheme:
DMX+: Yellow
DMX-: Pink
DMX Shield: Orange
- Installation may require shielded cable if EMI is present.
- Fixture Default Mode: FULL ON
- Fixture Fail Mode: ON 10% DIMMED