

SQUILINDER® LVS FIXED SUSPENDED MOUNT

A modern update to a timeless form, this award-winning, fresh-faced classic offers sleek geometry, field-changeable optics, and endless adjustability.

PROJECT NAME:	TYPE:
---------------	-------

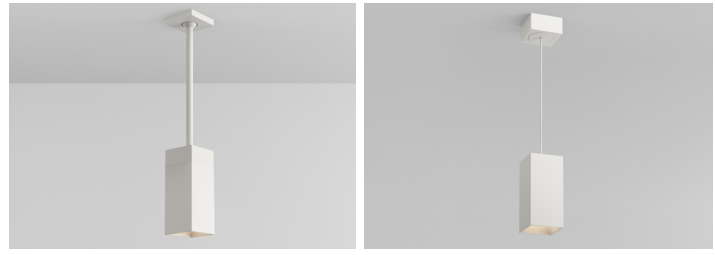

ORDERING INFORMATION - SQUILINDER

Quick Ship Product. All rough in components ship within 10 days up to quantities of 100.

SQUILINDER	LENGTH	FIXTURE	RATING	SQUILINDER FINISH	BAFFLE FINISH	CRI / WATTAGE PACKAGE	CCT	OPTIC (UGR)	DRIVER	MEDIA	MOUNTING
			1						LVS		
Dropkit® STEM ASSEMBLY SD2 3.13"	043 2" - 43" Mechanical Dropkit Stem	FB Fixed Body WW Wallwash Unibody	1 Dry/Damp	WH White AG Satin Silver* <i>*(Increased lead time)</i>	WH White AG Satin Silver* <i>*(Increased lead time)</i>	STATIC WHITE 80S11A 80+ CRI, 11 Watts Lm. Delivered - 1278 80S17A 80+ CRI, 17 Watts Lm. Delivered - 1960 80S23A 80+ CRI, 23 Watts Lm. Delivered - 2541 90S11A 90+ CRI, 11 Watts Lm. Delivered - 1098 90S17A 90+ CRI, 17 Watts Lm. Delivered - 1684 90S23A 90+ CRI, 23 Watts Lm. Delivered - 2183 97S11A 97+ CRI, 11 Watts Lm. Delivered - 964 97S17A 97+ CRI, 17 Watts Lm. Delivered - 1479 97S23A 97+ CRI, 23 Watts Lm. Delivered - 1917	24 2400K* <i>*(90+ CRI only, 17W max)</i>	10 10° (-19) <i>*(17W packages only)</i>	LVS Low Voltage System	STANDARD MEDIA 40 Soft Focus Lens* <i>*(Required for 10" optic)</i> WW Wallwash Lens* <i>*(Required for Wallwash fixtures)</i> ALTERNATE MEDIA 00 No Lens* <i>*(Not available for Warm Dim)</i> 20 Honeycomb Louver* <i>*(Not available for Warm Dim)</i> 30 Clear Glass Lens* <i>*(Not available for Warm Dim)</i> 50 Frosted Glass Lens 60 Frosted Soft Focus Lens 70 Frosted Linear Spread Lens SL Soft Focus Lens w/ Linear Spread Film CL Clear Glass Lens w/ Linear Spread Film	ROUGH-IN JBMP 4" Sq. or 4/0 Junction Box Mounting Plate FINISH OUT CMJB 1/2" and 3/4" Conduit Ceiling Mount Junction Box* <i>*(Quick Ship Product for WH and BK finishes only) </i>
	086 45" - 86" Mechanical Dropkit Stem			AB Architectural Bronze* <i>*(Increased lead time)</i>	AB Architectural Bronze* <i>*(Increased lead time)</i>		27 2700K	15 15° (-16)			
	129 88" - 129" Mechanical Dropkit Stem			BK Black	BK Black		30 3000K	20 20° (-13)			
	172 131" - 172" Mechanical Dropkit Stem			CF Custom Finish* <i>*(Consult Factory)</i>	CF Custom Finish* <i>*(Consult Factory)</i>		35 3500K	25 25° (-16)			
	<i>*(All lengths are field cuttable)</i>						40 4000K	40 40° (-16)			
PENDANT SP2 3.13"	XXXB Black Cable	FB Fixed Body	1 Dry/Damp	WH White	WH White	WARM DIM 90W18A 90+ CRI, 18 Watts Incandescent Profile Lm. Delivered - 1153 Halogen Profile Lm. Delivered - 1130 *SEE PAGE 5 FOR DETAILED WARM DIM PROFILE COMPARISON.	WL 2700K - 1800K	20 20° (-10)			
	XXXW White Cable			AG Satin Silver* <i>*(Increased lead time)</i>	AG Satin Silver* <i>*(Increased lead time)</i>		25 25° (-10)				
	Specify cable length in whole inches (Max 180) ex. specify 006B for a 6 inch black cable* <i>*(Cable is field cuttable)</i>			AB Architectural Bronze* <i>*(Increased lead time)</i>	AB Architectural Bronze* <i>*(Increased lead time)</i>		40 40° (-13)				
				BK Black	BK Black		60 60° (-16)				
				CF Custom Finish* <i>*(Consult Factory)</i>	CF Custom Finish* <i>*(Consult Factory)</i>		WW Wallwash* <i>*(Required for WW)</i>				
					TUNABLE WHITE 90T17A 90+ CRI, 17 Watts Warm Profile Lm. Delivered - 991 Cool Profile Lm. Delivered - 982 *ALL DELIVERED LUMEN OUTPUTS REFLECT 3000K PAIRED WITH 20° OPTIC AND SOFT FOCUS LENS.	TR 4000K - 1800K	10 10° (-19) <i>*(17W packages only)</i>				
						TH 5000K - 2700K	15 15° (-16)				
							20 20° (-13)				
							25 25° (-16)				
							40 40° (-16)				
							60 60° (-19)				
							WW Wallwash* <i>*(Required for WW)</i>				
							*SEE PAGE 4 FOR UGR RATINGS				

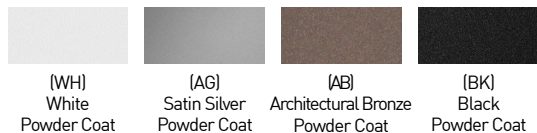

PART NUMBER NOTES



- SD2 ships as e.g., SQ2-AD1-WHBK-90S23A2-30LVS40
- Stem Assembly ships as SQ2-DK-(length)-(finish)
- SP2 ships as e.g., SP2-1801-WHBK-90S23A2-30LVS40W
- Mounting ships separate from fixture, part numbers listed on page 7.

SQUILINDER LVS FIXED SUSPENDED MOUNT

APPLICATION NOTES

- Lucifer Lighting will not supply a fixture with a POE node or power supply inside the fixture. This allows for easier site install with nodes of 2 or more outputs.
- Consult node manufacturer for maximum remote wiring distances.
- Fixture features 18 Gauge wiring.
- Wiring connections are made on the fixture using customer supplied connectors, ex. wire nuts, push-in connectors, or terminal blocks.
- Confirm node compatibility with factory if it is not listed.
- Customers are responsible for ensuring POE node drive current is set to correct values shown below.
- Customers must ensure voltage range of the proposed POE node encompasses the fixtures complete Vf range, both maximum and minimum. If assistance is required contact LLC rep or factory.

NODE COMPATIBILITY

Manufacturer	Model Number
 Igor Enabling Smart Buildings™	NP50-60-C-F-5
 molex	180996-1001 180996-1002 180996-2001 180996-2002
 PLATFORMATICS	1 Channel Node, POE-LN2-1U-E 2 Channel Node, POE-LN2-2U-E 4 Channel Node, POE-LN2-4U-E

DRIVE CURRENT SPECIFICS

	80S			90S			97S			90W		90T	
	11A	17A	23A	11A	17A	23A	11A	17A	23A	18AL	18AD	17AR	17AT
Minimum Vf	30.5	30.5	30.5	30.5	30.5	30.5	30.5	30.5	30.5	30.5	30.5	30.5	30.5
Maximum Vf	39	39	39	39	39	39	39	39	39	39	39	39	39
Current mA	250	400	550	250	400	550	250	400	550	400	400	400	400
Wattage W	8.2	13.6	19.4	8.2	13.6	19.4	8.2	13.6	19.4	13.6	13.6	14.4	14.4

	10 DEGREE OPTIC		
	80S17C	90S17C	97S17C
Minimum Vf	30.5	30.5	30.5
Maximum Vf	39	39	39
Current mA	400	400	400
Wattage W	13.6	13.6	13.6

WIRING DIAGRAM

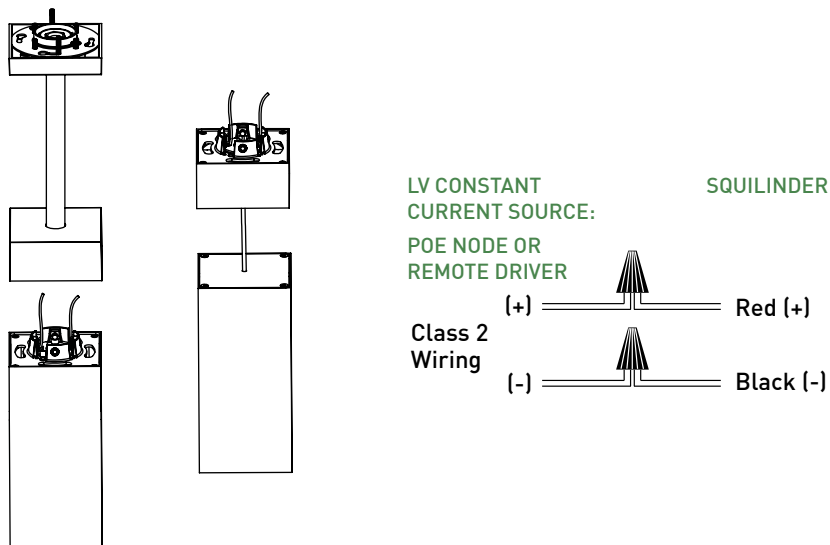

SQUILINDER LVS FIXED SUSPENDED MOUNT

ACCESSORIES

ALTERNATE BAFFLE AND MEDIA

Includes baffle with sealed lens. Must specify baffle finish.

RBA-SQ2--HCL-2** Honeycomb Louver *

*(Not available for Warm Dim)

RBA-SQ2--CGL-2** Clear Glass Lens *

*(Not available for Warm Dim)

RBA-SQ2--SFL-2** Soft Focus Lens

RBA-SQ2--FGL-2** Frosted Glass Lens

RBA-SQ2--FSFL-2** Frosted Soft Focus Lens

RBA-SQ2--FLSL-2** Frosted Linear Spread Lens

RBA-SQ2--SFL-LSL-2** Soft Focus Lens W/ Linear Spread Film

RBA-SQ2--CGL-LSL-2** Clear Glass Lens W/ Linear Spread Film

** Baffle finish: Specify **WH** for white, **BK** for black, **AG** for satin silver or

AB for architectural bronze.

STATIC WHITE REPLACEMENT OPTICS

RO-70-15-S 15° optic

RO-70-20-S 20° optic

RO-70-25-S 25° optic

RO-70-40-S 40° optic

RO-70-60-S 60° optic

RO-70-WW-S Wallwash optic

WARM DIM REPLACEMENT OPTICS

RO-70-20-W 20° optic

RO-70-25-W 25° optic

RO-70-40-W 40° optic

RO-70-60-W 60° optic

RO-70-WW-W Wallwash optic

STATIC WHITE REPLACEMENT OPTICS

RO-70-15-T 15° optic

RO-70-20-T 20° optic

RO-70-25-T 25° optic

RO-70-40-T 40° optic

RO-70-60-T 60° optic

RO-70-WW-T Wallwash optic

Dropkit STEM EXTENSION

RPS-DK-EXT--2** 2" - 43" Stem Extension

** Stem finish: Specify **WH** for white, **BK** for black, **AG** for satin silver or **AB** for architectural bronze.

REPLACEMENT SUCTION TOOL

Included with each order (1 per 10 fixtures).

CY-SQ-TOOL-SUCTION Baffle assembly removal tool

EMERGENCY LIGHTING - REMOTE MOUNT ONLY

EMB-S-25-120/277-LEDX 25 watt max capacity, 120 or 277 VAC 60Hz

EMB-S-100-120-LEDX 100 watt max capacity, 120 VAC 60Hz, 0-10V dimmable

EMB-S-100-277-LEDX 100 watt max capacity, 277 VAC 60Hz, 0-10V dimmable

EMB-S-250-120/277-LEDX 250 watt max capacity, 120 or 277 VAC 60Hz

During disruption of main power, emergency battery inverter provides temporary 120V or 277V to fixture.

SQUILINDER LVS FIXED SUSPENDED MOUNT

WALLWASH DESIGN GUIDE



**8FT MOUNTING HEIGHT
36" SETBACK / 48" ON CENTER SPACING**

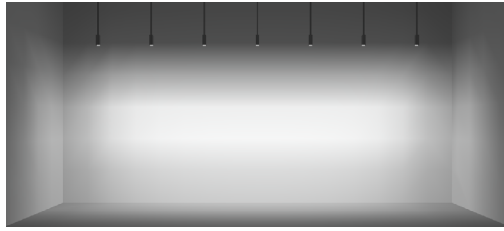

**10FT MOUNTING HEIGHT
36" SETBACK / 48" ON CENTER SPACING**



**12FT MOUNTING HEIGHT
36" SETBACK / 48" ON CENTER SPACING**

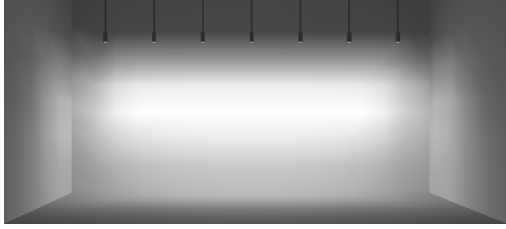

30" SETBACK / 42" ON CENTER SPACING

- AVERAGE FC: 17.19
- MAX / MIN: 5.71
- 10FT MOUNTING HEIGHT / 8-12FT IDEAL
- 7 FIXTURES / 25FT WALL SHOWN



RECOMMENDED

36" SETBACK / 48" ON CENTER SPACING

- AVERAGE FC: 13.81
- MAX / MIN: 6.21
- 10FT MOUNTING HEIGHT / 8-12FT IDEAL
- 7 FIXTURES / 32FT WALL SHOWN



42" SETBACK / 54" ON CENTER SPACING

- AVERAGE FC: 11.14
- MAX / MIN: 7.32
- 10FT MOUNTING HEIGHT / 8-12FT IDEAL
- 7 FIXTURES / 32FT WALL SHOWN

ADDITIONAL SETBACKS AND SPACINGS

ON CENTER SPACING	SETBACK		
	30"	36"	42"
30"	SHOWN ABOVE	AVERAGE FC: 13.93 MAX / MIN: 8.07	AVERAGE FC: 12.54 MAX / MIN: 8.54
36"	AVERAGE FC: 14.00 MAX / MIN: 6.22	SHOWN ABOVE	AVERAGE FC: 11.34 MAX / MIN: 7.78
42"	AVERAGE FC: 12.18 MAX / MIN: 7.73	AVERAGE FC: 11.04 MAX / MIN: 8.67	SHOWN ABOVE

***ALL DATA REFLECTS 90S17A LUMEN PACKAGE**

SQUILINDER LVS FIXED SUSPENDED MOUNT

STATIC WHITE PERFORMANCE - 3000K - SOFT FOCUS LENS

WATTAGE PACKAGE	WATTAGE	10° OPTIC SOFT FOCUS LENS		15° OPTIC SOFT FOCUS LENS		20° OPTIC SOFT FOCUS LENS		25° OPTIC SOFT FOCUS LENS		40° OPTIC SOFT FOCUS LENS		60° OPTIC SOFT FOCUS LENS		WW OPTIC WALLWASH LENS	
		DLVD	LPW	DLVD	LPW	DLVD	LPW	DLVD	LPW	DLVD	LPW	DLVD	LPW	DLVD	LPW
80S11A	11	-	-	1289	117	1278	116	1282	117	1222	111	1154	105	913	83
80S17A/C	17	716	42	1916	113	1960	115	1925	113	1846	109	1737	102	1395	82
80S23A	23	-	-	2440	106	2541	110	2515	109	2383	104	2240	97	1814	79
90S11A	11	-	-	1107	101	1098	100	1101	100	1050	95	991	90	784	71
90S17A/C	17	617	36	1646	97	1684	99	1654	97	1586	93	1492	88	1198	70
90S23A	23	-	-	2096	91	2183	95	2161	94	2047	89	1924	84	1558	68
97S11A	11	-	-	972	88	964	88	967	88	922	84	870	79	688	63
97S17A/C	17	532	31	1445	85	1479	87	1452	85	1392	82	1310	77	1052	62
97S23A	23	-	-	1840	80	1917	83	1897	82	1797	78	1689	73	1368	59
90W18AL (2700K-1800K)	18	-	-	-	-	1153	64	1133	63	1095	61	1037	58	858	48
90W18AD (3000K-1800K)	18	-	-	-	-	1130	63	1132	63	1093	61	1047	58	881	49
90T17ATR (4000K-1800K)	17	-	-	985	58	991	59	999	59	938	56	904	54	923	55
90T17ATH (5000K-2700K)	17	-	-	977	58	982	58	990	59	930	55	896	53	905	54

MEDIA LIGHT LOSS MULTIPLIER

MEDIA	LIGHT LOSS FACTOR
No Lens	1.06
SFL	1.00
CGL	0.98
FGL	0.91
FSFL	0.87
FLSL	0.82
SFL W/ LIN. SPREAD	0.76
CGL W/ LIN. SPREAD	0.74
HCL	0.73

OUTPUT MULTIPLIER

CCT	CCT SCALE
2400K	0.76
2700K	0.97
3000K	1.00
3500K	1.03
4000K	1.08

TUNABLE WHITE MULTIPLIER

CCT	5000K-2700K	4000K-1800K
5000K	1.16	-
4000K	1.08	1.14
3500K	1.04	1.07
3000K	1.00	1.00
2700K	0.96	0.92
2400K	-	0.84
1800K	-	0.69

UNIFIED GLARE RATING

10° OPTIC SOFT FOCUS LENS	15° OPTIC SOFT FOCUS LENS	20° OPTIC SOFT FOCUS LENS	25° OPTIC SOFT FOCUS LENS	40° OPTIC SOFT FOCUS LENS	60° OPTIC SOFT FOCUS LENS
>19	<16	<13	<16	<16	<19

WARM DIM PERFORMANCE - SOFT FOCUS LENS - 20° OPTIC

INCANDESCENT DIMMING PROFILE

90W18AL 2700K - 1800K	Full on 100%	Dimmed to 80%	Dimmed to 70%	Dimmed to 50%	Dimmed to 20%	Dimmed to 10%	Dimmed to 2%
CCT (K)	2700	2650	2620	2520	2180	1950	1800
Light Output (Lm)	1153	922	807	576	231	115	23
Power (W)	18	14	13	9	4	2	.4
Efficacy (LPW)	64	64	64	64	64	64	64

STANDARD WARM DIM PROFILE

90W18AD 3000K - 1800K	Full on 100%	Dimmed to 80%	Dimmed to 70%	Dimmed to 50%	Dimmed to 20%	Dimmed to 10%	Dimmed to 2%
CCT (K)	3000	2950	2920	2775	2375	2000	1800
Light Output (Lm)	1130	904	791	565	226	113	23
Power (W)	18	14	13	9	4	2	.4
Efficacy (LPW)	62	62	62	62	62	62	62

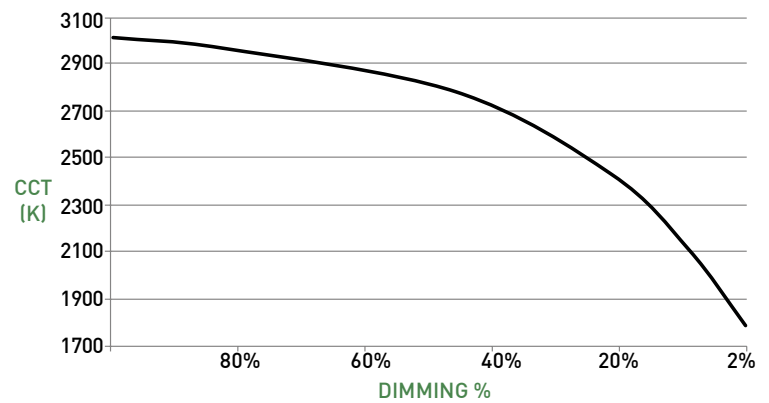
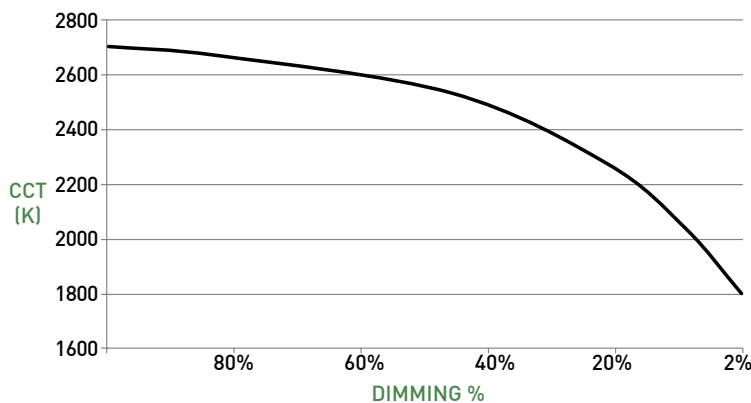

SQUILINDER LVS FIXED SUSPENDED MOUNT

Dropkit STEM ASSEMBLY

- A LUMINAIRE**
Machined body with integral heat sink and LED. Power supply must be remote mount.
- B1 FIXED BODY OPTICS**
Robust light engine with optimized optic pairing integrates Reflection, Refraction, and TIR offering 10°, 15°, 20°, 25°, 40° & 60° beams.
- WALLWASH OPTIC**
Precision tuned optic provides uniform wallwashing effect.
- B2 10° FIELD REDUCER**
Included with 10° optic. Reduces field angle by 6%
- C FIXED BODY MEDIA**
Soft focus lens standard; lenses sealed in place. Fixture can accept 1 media.
- WALLWASH MEDIA**
Wallwash lens is sealed in place. Fixture can accept 1 media.
- D BAFFLE**
Baffle minimizes aperture glare and conceals view into fixture. Suction tool provided for removal of baffle.
- E Dropkit**
 - Field cuttable rigid stem for suspending fixture at desired height. Provides stable base to allow preferred fixture tilt, while maintaining vertical stem position.
 - Ball joint allows up to 45° tilt for sloped ceilings and can be locked once stem is positioned vertically.
 - Four 43" sections available; 172" maximum standard length.
 - Length adjustment occurs in lower canopy.
 - Wiring for stem assembly provided by others.

DIMENSIONS / DRAWINGS

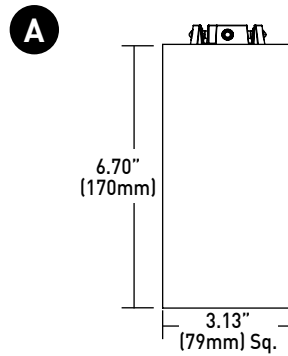

FIXED BODY

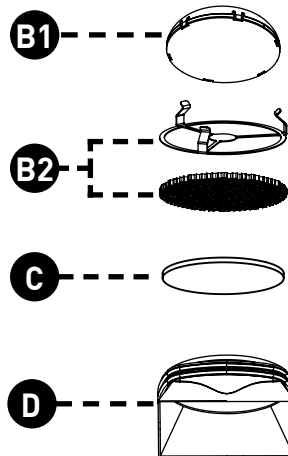

WALLWASH UNIBODY

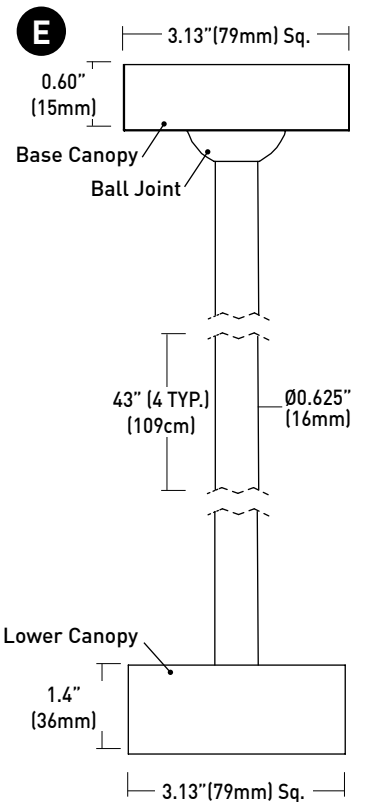
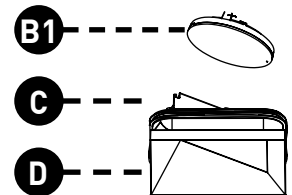
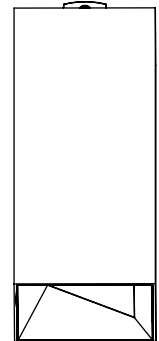

SQUILINDER LVS FIXED SUSPENDED MOUNT

PENDANT

- F CANOPY**
Machined 1.60" (41mm) canopy accommodates flat and slope ceiling conditions. Conceals hidden mounting hardware. Available with integral or remote driver.
- G CABLE**
Black and white wiring harness available; up to 180.0" length; cable may be cut in field.
- H LUMINAIRE**
Machined body with integral heat sink and LED.
- I1 STANDARD OPTICS**
Proprietary optics available in 10°, 15°, 25°, 40° & 60° beams.
- I2 10° FIELD REDUCER**
Included with 10° optic. Reduces field angle by 6%
- J MEDIA**
Soft focus lens standard; lenses sealed in place. Fixture can accept 1 media.
- K BAFFLE**
Baffle minimizes aperture glare and conceals view into fixture. Suction tool provided for removal of baffle.

DIMENSIONS / DRAWINGS

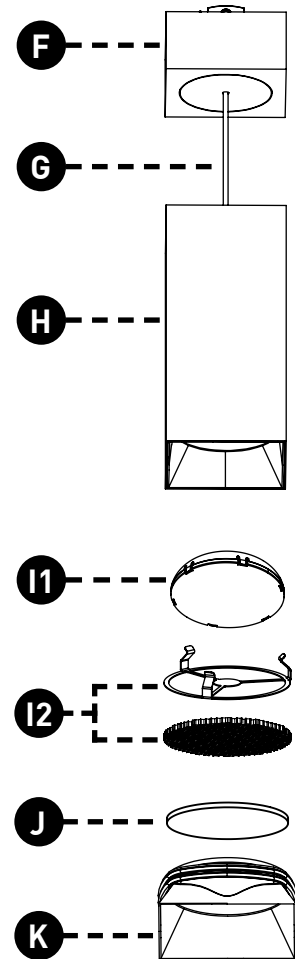
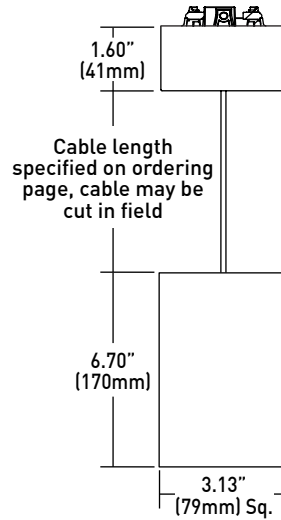

SQUILINDER LVS FIXED SUSPENDED MOUNT

Dropkit STEM AND PENDANT MOUNTING

- L JBMP**
Mounting plate (concealed) for standard 4" square or 4" 4/0 j-box . To be installed during rough-in prior to substrate. Fixture to mount flush with minimalist transition to ceiling.
Part Number - SQ2-JBMP
- M SMK3**
Surface mount kit includes mounting plate and 4" concealer plate that installs between fixture and standard 3" 3/0 j-box for existing applications where standard j-box cutout is to be concealed.
Part Number - SQ2-SMK-3/0-(FINISH)
- N SMK4**
Surface mount kit includes mounting plate and 5" concealer plate that installs between fixture and standard 4" 4/0 j-box for existing applications where standard j-box cutout is to be concealed.
Part Number - SQ2-SMK-4/0-(FINISH)
- O CMJB**
Ceiling mount junction box perfectly matches the squilinder profile for a continuous, integrated look where exposed ceiling mount junction box and conduit applications apply. For use with 1/2" and 3/4" EMT conduit only. Features three conduit entrances at 12, 3, and 6 o'clock plus one conduit knockout on top. Painted finishes only. Blank off plugs included.
Part Number - SQ2-CMJB-(FINISH)

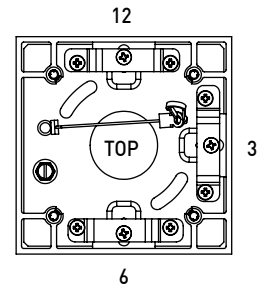
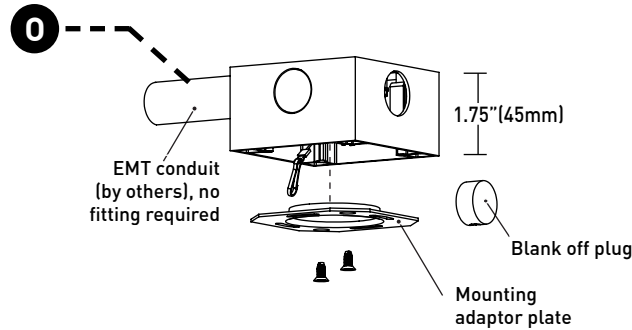
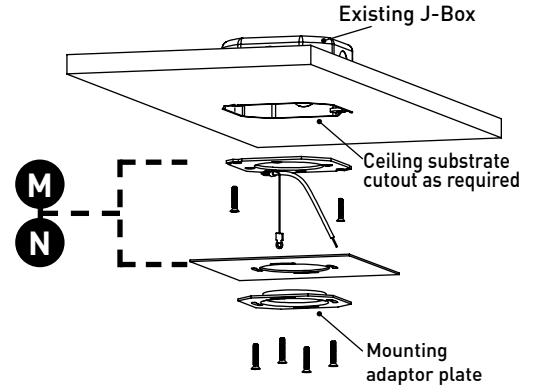
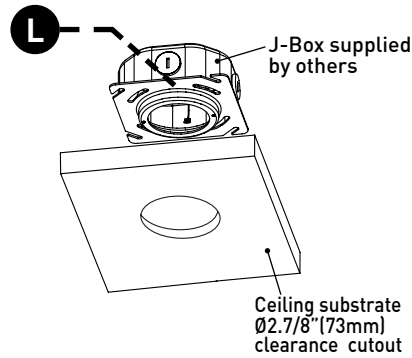

MOUNTING NOTES

- JBMP not recommended for use with pancake style j-box.
- For applications involving slat ceilings or confined mounting, consult Comprehensive Install Guide for required clearances for proper air flow and servicing.

SQUILINDER LVS FIXED SUSPENDED MOUNT

TECHNICAL

CONSTRUCTION

Squilinder: Machined aluminum body; painted finishes are granulated powder coat.

Dropkit Stem Assembly: Die-cast aluminum canopies and extruded aluminum stems; painted finishes are granulated powder coat.

CMJB: Die-cast aluminum body; painted finishes are granulated powder coat.

STATIC WHITE LED

2-step MacAdam ellipse LED module available in 80+, 90+ and 97+ CRI configurations in color temperatures of 2700K, 3000K, 3500K and 4000K. 3-step MacAdam ellipse LED module available in 90+ CRI configuration in color temperature of 2400K. Average rated lamp life of 50,000 hours. LED and driver assemblies are field-replaceable.

WARM DIM LED

3-step MacAdam ellipse warm dim LED module available in 90+ CRI configuration. 3000K or 2700K at full brightness, warming to 1800K at full dim. Average rated lamp life of 50,000 hours. LED and driver assemblies are field-replaceable.

TUNABLE WHITE LED

3-step MacAdam ellipse tunable white LED module available in 90+ CRI configuration. Features tuning range of 2700K to 5000K and 1800K to 4000K. Average rated lamp life of 50,000 hours. Driver assemblies are field-replaceable.

WALLWASH SPACING

Factory recommends 48" (1219mm) spacing on center with 36" (914mm) setback from wall plane.

MOUNTING

Pendant is supplied with a mounting adaptor plate, which integrates with specified mounting component. Dropkit Stem integrates directly with specified mounting component. JBMP provides a minimalist transition from standard 4/0 or 4" square junction boxes and accommodating ceiling thicknesses of 0.44" (12mm) to 0.75" (19mm). Ceiling-mount junction box available for 1/2" (13mm) and 3/4" (19mm) conduit and feature concealed internal clamps for clean fitting-free conduit exit and entry.

LISTING

cTUVus listed to UL2108 standard for Dry / Damp (IP10) locations. NEMA 410 compliant.

FIXTURE WEIGHT

SD2 and Mounting - 5.8 lbs

SP2 and Mounting - 4.6 lbs

LIMITED WARRANTY

Manufacturer's 1-year warranty guarantees product(s) listed to be free from defects in material and workmanship under normal use and service. 5-year warranty on LED to operate with 70% of the original flux and remain within a range of 3 duv. Warranty period begins from the date of shipment by Seller. [Consult website for full warranty terms and conditions.](#)

CHANGE LOG

- 01/12/2021: ADDED 2200K, 2700K-1800K WARM DIM AND 10 DEGREE OPTIC OFFERINGS.
- 03/17/2021: ADDED SMK MOUNTING OPTION FOR PENDANT
- 03/17/2021: ADDED CMJB MOUNTING OPTION FOR DROPKIT.
- 04/29/2021: ADDED LP1 DRIVER OFFERING.
- 06/09/2022: ADDED HONEYCOMB LOUVER, SOFT FOCUS LENS W/ LINEAR SPREAD FILM, AND CLEAR GLASS LENS W/ LINEAR SPREAD FILM.
- 10/17/2022: REMOVED 90W13A 3200K-1800K WARM DIM AND ADDED 90W18AD 3000K-1800K WARM DIM.
- 08/08/2023: ADDED NEW LED AND OPTIC OFFERINGS. REMOVED 2200K OFFERING.
- 11/2024: ADDED 2400K OFFERING.
10. 2/07/2024: ADDED TUNABLE WHITE OFFERING.
10. 3/15/24: ADDED 10 DEGREE FIELD REDUCER, UPDATED 10 DEGREE PERFORMANCE DATA.