

CYLINDER 2 SUSPENDED STEM DROPKIT

ACCESSORIES

REPLACEMENT MEDIA

- SFL-CY2X-03** Soft Focus Lens
- HCL-CY2X-03** Honeycomb Louver *
*(Not available for Warm Dim)
- CGL-CY2X-03** Clear Glass Lens *
*(Not available for Warm Dim)
- FGL-CY2X-03** Frosted Glass Lens
- FSFL-CY2X-03** Frosted Soft Focus Lens
- FLSL-CY2X-03** Frosted Linear Spread Lens
- CGL-HCL-CY2X-03** Clear Glass Film W/ Honeycomb Louver
- SFL-HCL-CY2X-03** Soft Focus Film W/ Honeycomb Louver

Dropkit STEM EXTENSION

- RPS-DK-EXT-**** 2-42" Stem Extension
- ** Stem finish: Specify **WH** for white, **AG** for satin Silver, **AU** for cashmere gold, **AB** for architectural bronze, **BB** for burnt bronze, or **BK** for black.

STATIC WHITE REPLACEMENT OPTICS

- RO-70-15-S** 15° optic
- RO-70-20-S** 20° optic
- RO-70-25-S** 25° optic
- RO-70-40-S** 40° optic
- RO-70-60-S** 60° optic

WARM DIM REPLACEMENT OPTICS

- RO-70-20-W** 20° optic
- RO-70-25-W** 25° optic
- RO-70-40-W** 40° optic
- RO-70-60-W** 60° optic

TUNABLE WHITE REPLACEMENT OPTICS

- RO-70-15-T** 15° optic
- RO-70-20-T** 20° optic
- RO-70-25-T** 25° optic
- RO-70-40-T** 40° optic
- RO-70-60-T** 60° optic

EMERGENCY LIGHTING - REMOTE MOUNT ONLY

During disruption of main power, emergency battery inverter provides temporary 120V or 277V to fixture.

- EMB-S-25-120/277-LEDX** 25 watt max capacity, 120 or 277 VAC 60Hz
- EMB-S-100-120-LEDX** 100 watt max capacity, 120 VAC 60Hz, 0-10V dimmable
- EMB-S-100-277-LEDX** 100 watt max capacity, 277 VAC 60Hz, 0-10V dimmable
- EMB-S-250-120/277-LEDX** 250 watt max capacity, 120 or 277 VAC 60Hz

***SHUNT REQUIRED FOR USE WITH ATHENA AND CASAMBI CONTROLS, CONSULT FACTORY FOR DETAILS.**

POWDERCOAT FINISHES

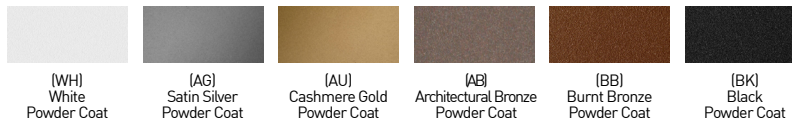

ALUMINA FINISHES BY LUCIFER LIGHTING™

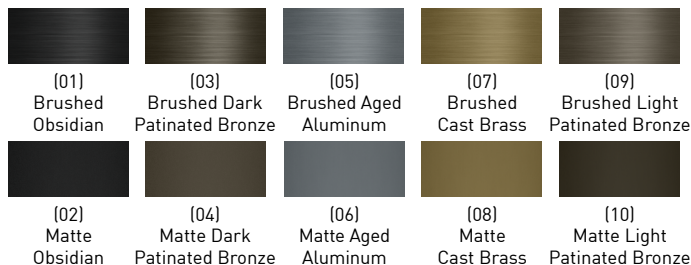

CYLINDER 2 SUSPENDED STEM DROPKIT

WALLWASH DESIGN GUIDE

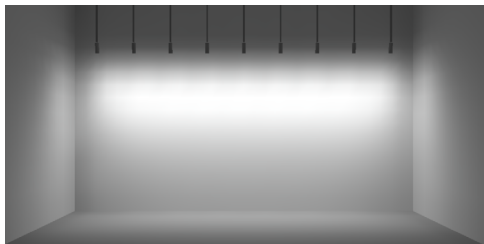

10° TILT

30" SETBACK / 30" ON CENTER SPACING

- 10FT CEILING SHOWN / 8-12FT IDEAL
- AVERAGE FC: 33.74
- MAX / MIN: 4.89
- 9 FIXTURES / 25FT WALL SHOWN



RECOMMENDED

15° TILT

36" SETBACK / 36" ON CENTER SPACING

- 10FT CEILING SHOWN / 8-12FT IDEAL
- AVERAGE FC: 30.07
- MAX / MIN: 4.35
- 9 FIXTURES / 25FT WALL SHOWN

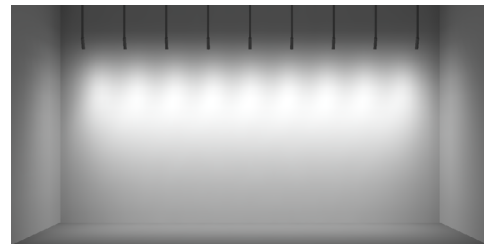

20° TILT

42" SETBACK / 42" ON CENTER SPACING

- 10FT CEILING SHOWN / 8-12FT IDEAL
- AVERAGE FC: 27.25
- MAX / MIN: 4.07
- 9 FIXTURES / 25FT WALL SHOWN



30" SETBACK / 42" ON CENTER SPACING

- 10FT CEILING SHOWN / 8-12FT IDEAL
- AVERAGE FC: 25.44
- MAX / MIN: 6.25
- 9 FIXTURES / 25FT WALL SHOWN

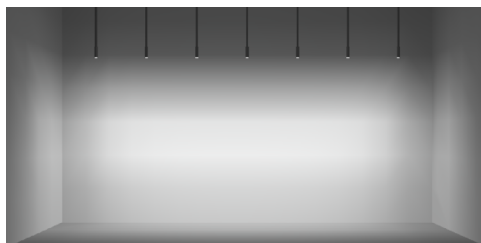

RECOMMENDED

36" SETBACK / 48" ON CENTER SPACING

- 10FT CEILING SHOWN / 8-12FT IDEAL
- AVERAGE FC: 20.44
- MAX / MIN: 6.06
- 9 FIXTURES / 30FT WALL SHOWN



42" SETBACK / 54" ON CENTER SPACING

- 10FT CEILING SHOWN / 8-12FT IDEAL
- AVERAGE FC: 16.48
- MAX / MIN: 6.24
- 9 FIXTURES / 35FT WALL SHOWN

ADDITIONAL SETBACKS AND SPACINGS

ON CENTER SPACING	SETBACK / TILT			ON CENTER SPACING	SETBACK		
	30" / 10°	36" / 15°	42" / 20°		30"	36"	42"
30"	SHOWN ABOVE	AVERAGE FC: 35.46 MAX / MIN: 4.37	AVERAGE FC: 36.51 MAX / MIN: 4.12	42"	SHOWN ABOVE	AVERAGE FC: 22.85 MAX / MIN: 6.30	AVERAGE FC: 20.41 MAX / MIN: 6.41
36"	AVERAGE FC: 28.80 MAX / MIN: 4.98	SHOWN ABOVE	AVERAGE FC: 31.27 MAX / MIN: 4.04	48"	AVERAGE FC: 22.75 MAX / MIN: 6.02	SHOWN ABOVE	AVERAGE FC: 18.24 MAX / MIN: 6.19
42"	AVERAGE FC: 25.13 MAX / MIN: 5.20	AVERAGE FC: 26.20 MAX / MIN: 4.42	SHOWN ABOVE	54"	AVERAGE FC: 20.53 MAX / MIN: 6.11	AVERAGE FC: 18.44 MAX / MIN: 6.09	SHOWN ABOVE

***ALL DATA REFLECTS 90S17A WATTAGE PACKAGE**

CYLINDER 2 SUSPENDED STEM DROPKIT

STATIC WHITE PERFORMANCE - 3000K

LUMEN PACKAGE	WATTAGE	10° OPTIC NO LENS		15° OPTIC SOFT FOCUS LENS		20° OPTIC SOFT FOCUS LENS		25° OPTIC SOFT FOCUS LENS		40° OPTIC SOFT FOCUS LENS		60° OPTIC SOFT FOCUS LENS		WALLWASH WALLWASH LENS		ADJ. WALLWASH WALLWASH LENS	
		DLVD	LPW	DLVD	LPW	DLVD	LPW	DLVD	LPW	DLVD	LPW	DLVD	LPW	DLVD	LPW	DLVD	LPW
80S11B	11	-	-	1095	99	1151	104	1151	104	1073	97	1018	92	706	64	917	83
80S17B/C	17	779	46	1651	97	1768	103	1789	105	1654	97	1583	93	1094	64	1416	83
80S23B	23	-	-	2201	95	2360	102	2374	103	2201	95	2112	91	1452	63	1884	81
90S11B	11	-	-	936	85	984	89	984	89	917	83	870	79	603	54	784	71
90S17B/C	17	671	39	1411	83	1511	88	1529	89	1414	83	1353	79	935	55	1210	71
90S23B	23	-	-	1881	81	2017	87	2029	88	1882	81	1805	78	1241	53	1610	70
97S11B	11	-	-	861	78	905	82	905	82	844	76	800	72	555	50	721	65
97S17B/C	17	579	34	1298	76	1390	81	1407	82	1301	76	1245	73	860	50	1113	65
97S23B	23	-	-	1731	75	1856	80	1867	81	1731	75	1661	72	1442	49	1481	64
90W24BL (2700K-1800K)	24	-	-	-	-	1530	66	1516	65	1425	61	1344	58	1137	49	1238	53
90W24BD (3000K-1800K)	24	-	-	-	-	1592	69	1582	68	1495	65	1419	61	1267	55	1305	56
90T32BTR (4000K-1800K)	32	-	-	2360	73	2472	77	2468	77	2326	72	2224	69	1669	52	2035	63
90T32BTH (5000K-2700K)	32	-	-	2254	70	2351	72	2334	71	2208	67	2105	59	1848	57	1910	59

MEDIA LIGHT LOSS FACTOR

MEDIA	LIGHT LOSS FACTOR
No Lens	1.07
CGL	0.98
SFL	1.00
FGL	0.94
FSFL	0.93
FLSL	0.85
HCL	0.72
SFL+HCL	0.66

OUTPUT MULTIPLIER

CCT	CCT SCALE
2400K	0.76
2700K	0.957
3000K	1.000
3500K	1.019
4000K	1.030

TUNABLE WHITE MULTIPLIER

CCT	5000K-2700K	4000K-1800K
5000K	1.16	-
4000K	1.08	1.14
3500K	1.04	1.07
3000K	1.00	1.00
2700K	0.96	0.92
2400K	-	0.84
1800K	-	0.69



JA8-2022 INDICATED BY SHADING

UNIFIED GLARE RATING

10° OPTIC SOFT FOCUS LENS	15° OPTIC SOFT FOCUS LENS	20° OPTIC SOFT FOCUS LENS	25° OPTIC SOFT FOCUS LENS	40° OPTIC SOFT FOCUS LENS	60° OPTIC SOFT FOCUS LENS	WALLWASH WALLWASH LENS
<13	<13	<10	<10	<10	<16	>19

WARM DIM PERFORMANCE - SOFT FOCUS LENS - 20° OPTIC

INCANDESCENT DIMMING PROFILE

90W24BL 2700K - 1800K	Full on 100%	Dimmed to 80%	Dimmed to 70%	Dimmed to 50%	Dimmed to 20%	Dimmed to 10%	Dimmed to 2%
CCT (K)	2700	2650	2620	2520	2180	1950	1800
Light Output (Lm)	1530	1224	1071	765	306	153	31
Power (W)	24	18	16	12	5	2.3	0.5
Efficacy (LPW)	66	66	66	66	66	66	66

HALOGEN DIMMING PROFILE

90W24BD 3000K - 1800K	Full on 100%	Dimmed to 80%	Dimmed to 70%	Dimmed to 50%	Dimmed to 20%	Dimmed to 10%	Dimmed to 2%
CCT (K)	3000	2950	2920	2775	2375	2000	1800
Light Output (Lm)	1592	1274	1114	796	318	159	32
Power (W)	24	18	16	12	5	2.3	0.5
Efficacy (LPW)	69	69	69	69	69	69	69

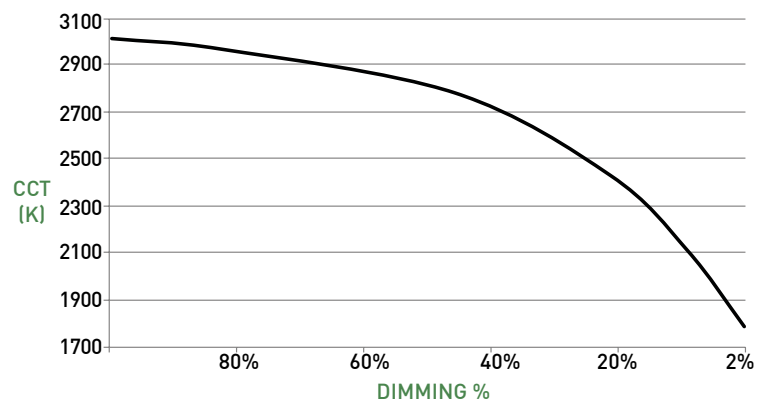
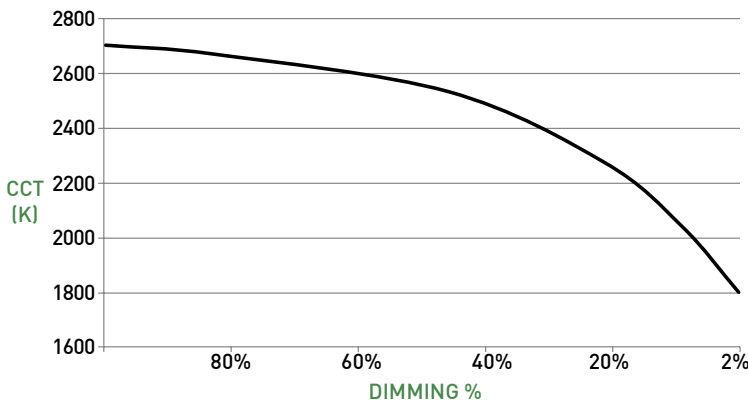

CYLINDER 2 SUSPENDED STEM DROPKIT

CYLINDER ASSEMBLY

- A ADJUSTABLE - STANDARD CANOPY**
Die-cast canopy accommodates flat and sloped ceiling conditions. Conceals hidden mounting hardware. "AD" (90° tilt, 365° rotation) canopy features 1.96" (79mm) tall canopy. Available with integral or remote driver.
- B ADJUSTABLE - SHALLOW CANOPY**
Die-cast canopy accommodates flat and slope ceiling conditions. Conceals hidden mounting hardware. "AS" (90° tilt, 365° rotation) canopy features 0.65" (17mm) tall canopy, reducing overall height. Requires remote power supply.
- C FIXED BODY**
Body with integrated heat sink and LED. Conceals mounting hardware. Power supply may be integral or remote mount.
- D WALLWASH FIXED BODY**
- E1 OPTICS**
Robust light engine with optimized optic pairing integrates Reflection, Refraction, and TIR offering 10°, 15°, 20°, 25°, 40° & 60° beams.
- E2 10° FIELD REDUCER**
Included with 10° optic. Reduces field angle by 56%
- F MEDIA**
Cylinder accepts 2 lenses; soft focus lens, no lens or wallwash lens standard. Sealed in place for Wet locations.
- G BAFFLE**
Die-cast baffle minimizes aperture glare and conceals view into fixture.
- H DROPKIT**
 - Field cuttable rigid stem for suspending fixture at desired height. Provides stable base to allow preferred fixture tilt, while maintaining vertical stem position.
 - Ball joint allows up to 45° tilt for sloped ceilings and can be locked once stem is positioned vertically.
 - Four 43" sections available; 172" maximum standard length.
 - Length adjustment occurs in lower canopy.
 - Wiring for kit provided by others.

DIMENSIONS / DRAWINGS

A ADJUSTABLE BODY STANDARD CANOPY

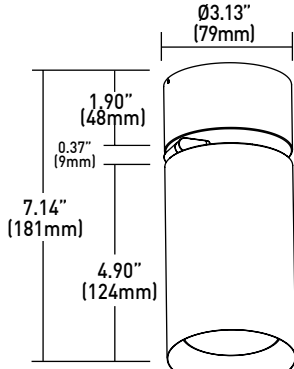

Cylinder weight
2.10 lbs

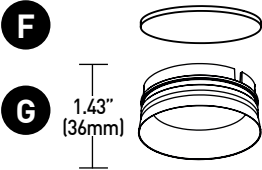
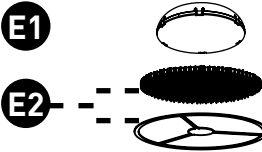

C FIXED BODY

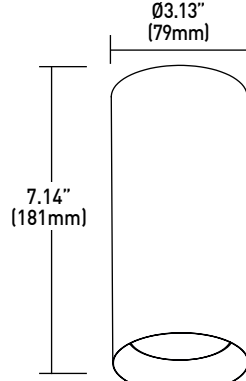

Cylinder weight
2.80 lbs

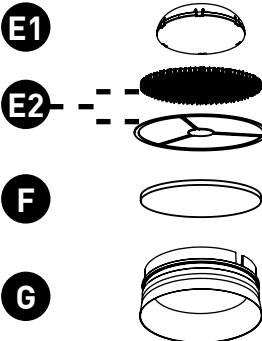

B ADJUSTABLE BODY SHALLOW CANOPY

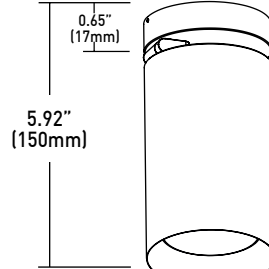

Cylinder weight
1.95 lbs

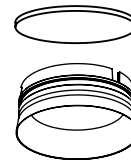

D WALLWASH FIXED BODY



Cylinder weight
3.00 lbs

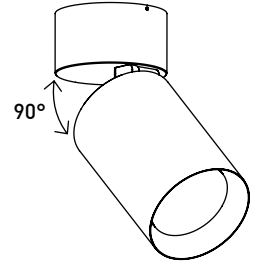

H DROPKIT

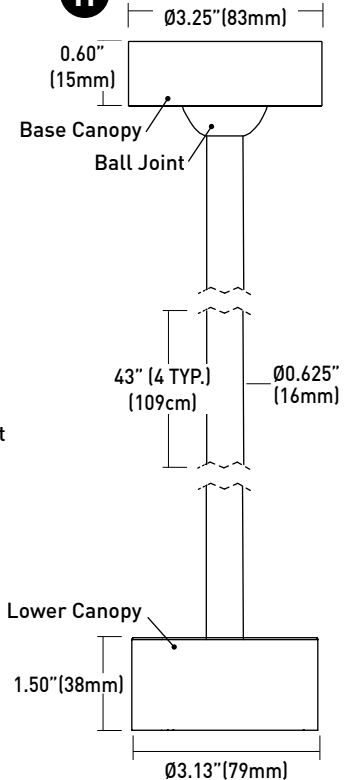

CYLINDER 2 SUSPENDED STEM DROPKIT

MOUNTING

- I JBMP**
Mounting plate (concealed) for standard 4" square or 4" 4/0 j-box. To be installed during rough-in prior to substrate. Fixture to mount flush with minimalist transition to ceiling.
Part Number - CDX-JBMP
- J SMK3**
Surface mount kit includes mounting plate and 4" concealer plate that installs between fixture and standard 3" 3/0 j-box for existing applications where standard j-box cutout is to be concealed.
Part Number - CDX-SMK-3/0-(FINISH)
- K SMK4**
Surface mount kit includes mounting plate and 5" concealer plate that installs between fixture and standard 4" 4/0 j-box for existing applications where standard j-box cutout is to be concealed.
Part Number - CDX-SMK-4/0-(FINISH)
- L CMJB**
Ceiling mount junction box perfectly matches the cylinder profile for a continuous, integrated look where exposed ceiling mount junction box and conduit applications apply. For use with 1/2" and 3/4" EMT conduit only. Features two conduit entrances on either side and one conduit knockout on top of j-box. J-box is IP10 rated; painted finishes only. Blank off plugs included.
Part Number - CDX-CMJB-(FINISH)

DIMENSIONS / DRAWINGS

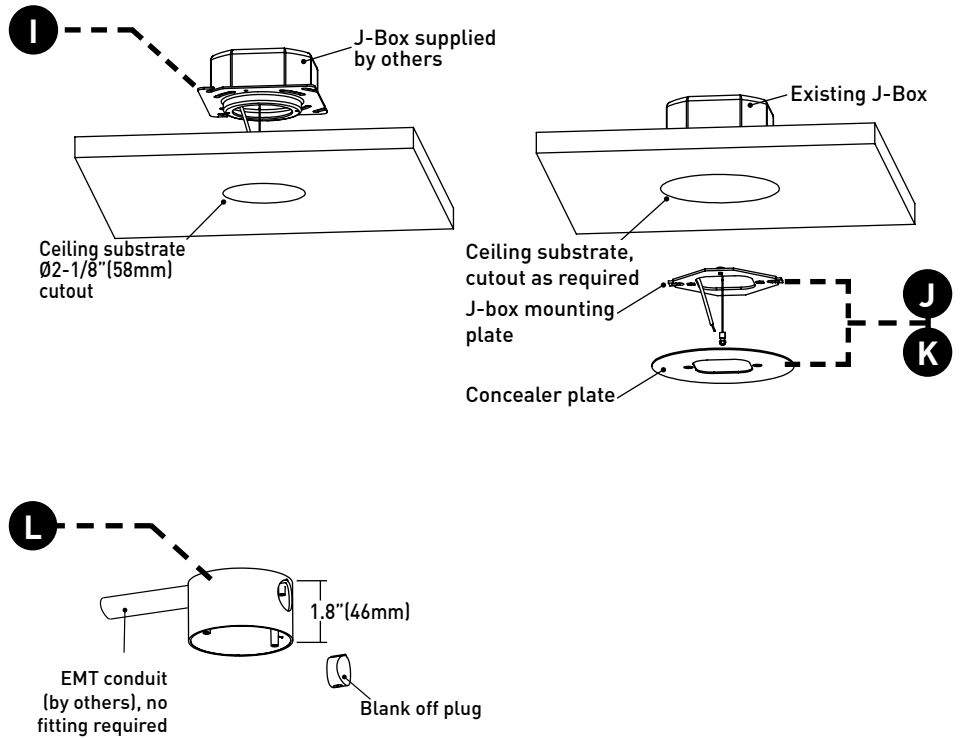

MOUNTING NOTES

- CDX-JBMP and CDX-SMK-3/0 & 4/0 not recommended for use with pancake style j-box.

REMOTE POWER SUPPLY

- M PS-RMT**
Remote power supply must be mounted in accessible area. Mounting device still required. Consult page 8 for dimming compatibility list. Consult install guide for complete details of suitable controls, wiring diagrams, and maximum allowable secondary run lengths between PS-RMT and cylinder.
- N ATHENA / CASAMBI CONTROL**
Controls integrated into remote driver assembly. All equipment is serviceable.
Athena Model Number: A-WN-D01-RF-BL & DC-OEM-DBI
Casambi Model Number: BT-S1E1-5400
- O ATHENA / CASAMBI EM SHUNT**
Included with drivers specified as ASR, ADR, CSR, or CDR. One required for each wireless EM fixture, requires class 2 control wiring between fixture and shunt. Features integrated test switch.
Model Number: PS-RMT-SHUNT

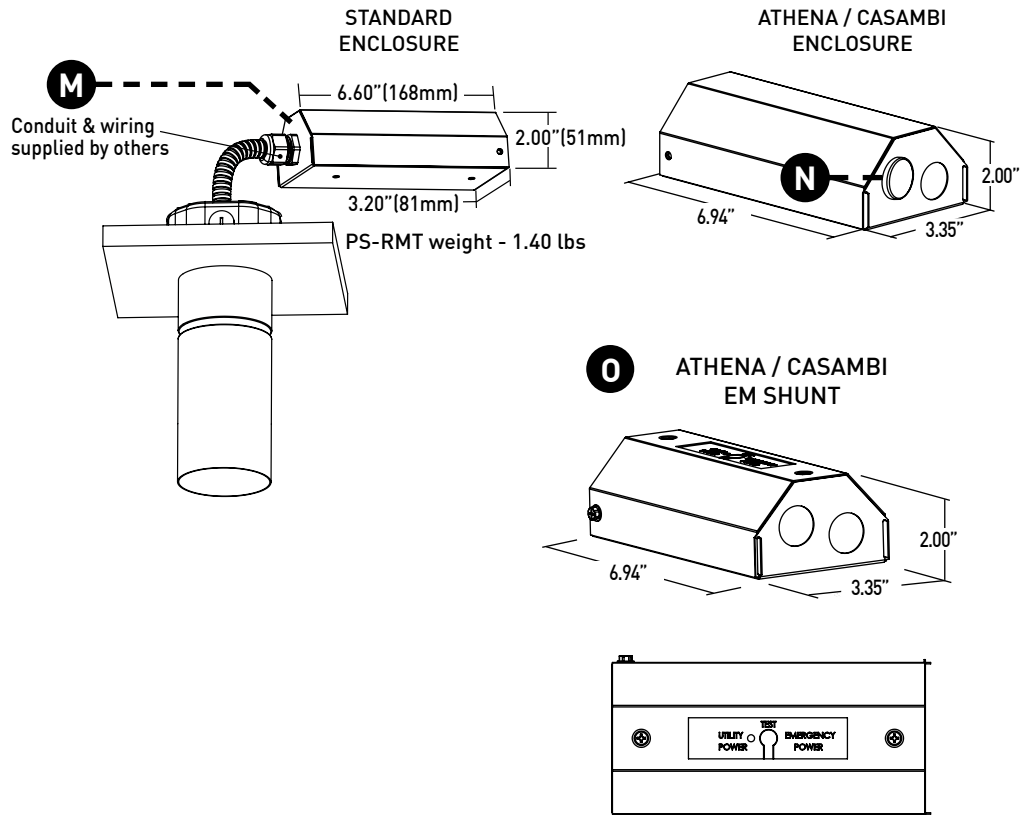

CYLINDER 2 SUSPENDED STEM DROPKIT

TECHNICAL

CONSTRUCTION

Cylinder: Die-cast aluminum body with integrated heat sink; painted finishes are granulated powder coat. Alumina finishes are anodized aluminum.

Dropkit Stem Assembly: Die-cast aluminum canopies and extruded aluminum stems; painted finishes are granulated powder coat.

CMJB: Die-cast aluminum body; painted finishes are granulated powder coat.

Remote Power Supply: 22 Gauge galvanized steel.

STATIC WHITE LED

2-step MacAdam ellipse LED module available in 80+, 90+ and 95+ CRI configurations in color temperatures of 2700K, 3000K, 3500K and 4000K. 3-step MacAdam ellipse LED module available in 90+ CRI configuration in color temperature of 2400K. Average rated lamp life: 50,000 hours. LED and driver assemblies are field-replaceable.

WARM DIM LED

3-step MacAdam ellipse warm dim LED module available in 90+ CRI configuration. 3000K or 2700K at full brightness, warming to 1800K at full dim. Average rated lamp life of 50,000 hours. LED and driver assemblies are field-replaceable.

TUNABLE WHITE LED

3-Step MacAdam ellipse tunable white LED module available in 90+ CRI configuration. Features tuning range of 2700K to 5000K and 1800K to 4000K. Average rated lamp life of 50,000 hours. Driver assemblies are field-replaceable.

POWER SUPPLY PERFORMANCE AND DIMMING INFORMATION

Power Supply	PHASE			0-10V							ECO	DALI			ATHENA	CASAMBI
	1CE/1RE	1TR	1L2	UCA/URA	UAN	ULN	UEG	UEN	UDG	UDN	ULH	UED	ULD	UDD	UAS/UAD	UCS/UCD
Minimum °C	-20 °C	-20 °C	0 °C	-20 °C	-20 °C	-20 °C	-20 °C	-20 °C	-20 °C	-20 °C	0 °C	-20 °C	-20 °C	-20 °C	0 °C	-20 °C
Maximum °C	40 °C	40 °C	40 °C	40 °C	40 °C	40 °C	40 °C	40 °C	40 °C	40 °C	40 °C	40 °C	40 °C	40 °C	40 °C	40 °C
Dimming %	1.0%	2.0%	1.0%	1.0%	1.0%	1.0%	0.1%	0.1%	0.1%	0.1%	1.0%	0.1%	0.1%	0.1%	0.1%	0.1%

Note: For 1TR, 1L2, ULH, UAN, ULN, UEG and UEN drivers consult chart on page 8 to confirm appropriate dimming curve for compatibility with selected control.

MAXIMUM ALLOWABLE REMOTE DRIVER WIRING DISTANCES

DRIVER	WIRE AWG				
	12	14	16	18	20
URA, 1RE	-	164'	105'	66'	40'
1TR, UAN, ULN	285'	180'	113'	71'	45'
1L2, ULH	60'	40'	25'	15'	-
UEG, UEN, UED, ULD, DD1, DG1, DN1, UAS, UCS, UAD, UCD	-	-	118'	72'	46'

WALLWASH SPACING AND TILT

Adjustable Wallwash Cylinder must be tilted to achieve wallwashing effect. Recommended adjustable spacing is 36" (914mm) on center with 36" (914mm) setback from wall plane with 15° tilt. Recommended fixed spacing is 36" (914mm) on center spacing with 48" (1219mm) setback from wall plane.

MOUNTING

Cylinder is supplied with a mounting adaptor plate, which integrates with required additional mounting accessories specified separately according to field application conditions, providing a minimalist transition from standard 4/0 or 4" square junction boxes and accommodating ceiling thicknesses of 0.44" (12mm) to 0.75" (19mm). Ceiling-mount junction box available for 1/2" (13mm) and 3/4" (19mm) conduit and feature concealed internal clamps for clean fitting-free conduit exit and entry.

LISTING

cTUVus listed to UL1598 standard for Dry / Damp (IP30) location. Title 24 JA8-2022 Listed. NEMA 410 Compliant. Buy American Act compliant.

DECLARE

LBC Red List Approved

WARRANTY

Manufacturer's 1-year warranty guarantees product(s) listed to be free from defects in material and workmanship under normal use and service. 5-year warranty on LED and power supply to operate with 70% of the original flux and remain within a range of 3 duv. 10-year Lutron Advantage limited warranty available on Lutron equipped systems. Warranty period begins from the date of shipment by Seller. Consult [website](#) for full warranty terms and conditions.

CHANGE LOG

1.03/15/2024: ADDED 10 DEGREE FIELD REDUCER, UPDATED 10 DEGREE PERFORMANCE DATA.

CYLINDER 2 SUSPENDED STEM DROPKIT

DIMMING COMPATIBILITY

PHILIPS DRIVER COMPATIBILITY

Power supply 1TR Manufacturer	Family/Model #
Lutron Electronics	DV-600P
Lutron Electronics	DVELV-303P
Lutron Electronics	NTELV-600
Lutron Electronics	MAELV-600
Lutron Electronics	SELV-300P
Lutron Electronics	DVLV-600P
Lutron Electronics	NFTU-5A
Lutron Electronics	CTCL-153P
Lutron Electronics	GL-600H
Lutron Electronics	S-600P
Lutron Electronics	PHPM
Power supply UAN / ULN Manufacturer	Family/Model #
Lutron Electronics	DVTV plus PP-DV
Lutron Electronics	DVSCV plus PP-DV
Lutron Electronics	DVSTV
Lutron Electronics	DVSCSTV
Lutron Electronics	QSGRJ-XP plus GRX-TVI
Lutron Electronics	QSGRJ-XE plus GRX-TVI
Lutron Electronics	QSGR-XE plus GRX-TVI
Lutron Electronics	NFTV plus PP-DV
Lutron Electronics	NTSTV
Lutron Electronics	RMJ-5T
Lutron Electronics	RMJS-8T
Lutron Electronics	FCJS-010
Leviton	IlumaTch IP7 series
Philips	Sunrise - SR1200ZTUNV

LUTRON DRIVER COMPATIBILITY

Power supply 1L2 Lutron Product Family	Part No.
Maestro WirelessR 600 W dimmer	MRF2-6ND-120-
Maestro WirelessR 1000 W dimmer	MRF2-10ND-120-
Caséta® Wireless Pro 1000 W dimmer	PD-10NXD-
GRAFIK T™ CL® dimmer	GT-250M-GTJ-250M-
HomeWorks® QS adaptive dimmer	HQRD-6NA-
HomeWorks® QS 600 W dimmer	HQRD-6ND-
HomeWorks® QS 1000 W dimmer	HQRD-10ND-
RadioRA® 2 adaptive dimmer	RRD-6NA-
RadioRA® 2 1000 W dimmer	RRD-10ND
myRoom™ DIN power module	MQSE-4A1-D
HomeWorks® QS DIN power module	LQSE-4A1-D
HomeWorks® QS wallbox power module	HQRJ-WPM-6D-120
HomeWorks® wallbox power module	HWI-WPM-6D-120
GRAFIK Eye® QS control unit	QSGR-, QSGRJ-
GRAFIK Eye® 3000 control unit	GRX-3100-GRX-3500-
RPM-4U module (LCP, HomeWorks® QS, GRAFIK Systems™, Quantum®)	HW-RPM-4U-120 LP-RPM-4U-120
RPM-4A module (LCP, HomeWorks® QS, GRAFIK Systems™, Quantum®)	HW-RPM-4A-120, LP-RPM-4A-120
GP dimming panels	Various
Ariadni CL 250W dimmer	AYCL-253P-
Diva CL 250W dimmer	DVCL-253P-DCSCCL-253P-
Nova T CL 250W dimmer	NTCL-250-
Power supply ULH Lutron Product Family	Part No.
PowPak Dimming Modules	RMJ-ECO32-DV-B
PowPak Dimming Modules	FCJ/FCJS-ECO
Energi Savr Nodes	QSN-1ECO-S
GRAFIK Eye QS control unit	QSN-2ECO-S
Homeworks QS control unit	QSGRJ- _E (wireless) QSGR- _E
Quantum Hub	QP2-__ 2C
Quantum Hub	QP2-__ 4C
Quantum Hub	QP2-__ 6C
Quantum Hub	QP2-__ 8C
Homeworks QS power module	LQSE-2ECO-D
myRoom Plus power module	

eldoLED DRIVER COMPATIBILITY

Power supply UEG / UEN Dimmer / Switch Control Manufacturer	Family/Model #
Busch-Jaeger	2112U-101
Jung	240-10
Leviton Lighting Controls	IP710-DLX
Lightolier Controls	ZP600FAM120
Lutron Electronics	Nova T® - NTFTV
Lutron Electronics	Div@ - DVTV
Lutron Electronics	Nova@ - NFTV
Merten	5729
Pass & Seymour	CD4FB-W
The Watt Stopper	DCLV1
Sensor Switch	nIO EZ
Synergy	ISD BC
Power supply UEG / UEN Lighting Control Systems Manufacturer	Family/Model #
Lutron Electronics	GrafixEye® GRX-TVI w GRX3503
Lutron Electronics	Energy Savr Node™ - QSN-4T16-S
Lutron Electronics	TVM2 Module
Crestron®	GLX-DIMFLV8
Crestron®	GLXP-DIMFLV8
Crestron®	GLPAC-DIMFLV4-*
Crestron®	GLPAC-DIMFLV8-*
Crestron®	GLPP-DIMFLVEX-PM
Crestron®	GLPP-1DIMFLV2EX-PM
Crestron®	GLPP-1DIMFLV3EX-PM
Crestron®	DIN-A08
Crestron®	DIN-4DIMFLV4
Crestron®	CLS-EXP-DIMFLV
Crestron®	CLCI-1DIMFLV2EX
ABB	SD/S 2.16.1

ANALOG DRIVERS AND DIMMERS

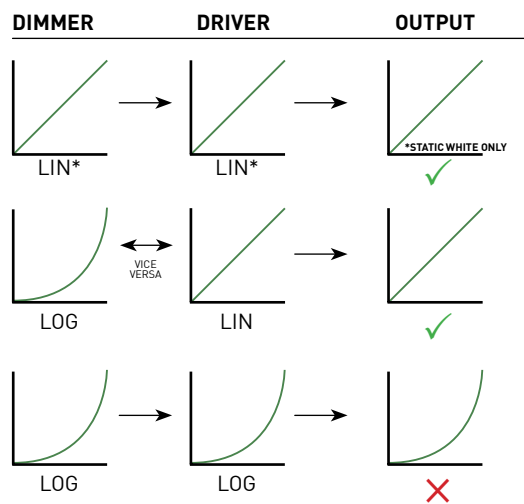

LIN = LINEAR
 LOG = LOGARITHMIC
 *LIN-TO-LIN NOT COMPATIBLE FOR WARM DIM

