

# TRACK HEAD INT STANDARD STEM CT2 WALLWASH

Give the most special art, objects, places, and spaces an elegant wash of soft light, with this classic, easy-to-adjust wallwash track head with an integrated kick reflector.

PROJECT NAME:	TYPE:
---------------	-------

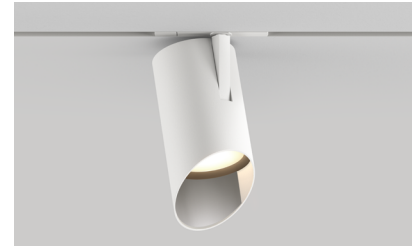

## ORDERING INFORMATION - TRACK HEAD

CYLINDER	FIXTURE	RATING	BODY FINISH	BAFFLE FINISH	ADAPTER FINISH	LUMEN PACKAGE	OCT	OPTIC (UGR)	DRIVER	MEDIA
CT2	AW	1		BK				WW	IE2	W
CT2 3.25"	AW 90° Adjustable Wallwash	1 Dry/Damp	<b>POWDERCOAT</b> WH White BK Black  <b>ALUMINA</b> 01 Brushed Obsidian 02 Matte Obsidian 03 Brushed Dark Patinated Bronze 04 Matte Dark Patinated Bronze 05 Brushed Aged Aluminum 06 Matte Aged Aluminum 07 Brushed Cast Brass 08 Matte Cast Brass 09 Brushed Light Patinated Bronze 10 Matte Light Patinated Bronze	POWDERCOAT BK Black	WH White BK Black	<b>STATIC WHITE</b> 80S11A 80+ CRI, 11 Watts Delivered Lumens - 819 80S17A 80+ CRI, 17 Watts Delivered Lumens - 1240 90S11A 90+ CRI, 11 Watts Delivered Lumens - 704 90S17A 90+ CRI, 17 Watts Delivered Lumens - 1065 97S11A 97+ CRI, 11 Watts Delivered Lumens - 618 97S17A 97+ CRI, 17 Watts Delivered Lumens - 935  <b>WARM DIM</b> 90W18A 90+ CRI, 18 Watts Incandescent Profile Delivered Lumens - 787  Standard Profile Delivered Lumens - 809  SEE PAGE 3 FOR DETAILED WARM DIM PROFILE COMPARISON.  LUMENS DELIVERED REFLECT 3000K.	24 2400K* * (90+ CRI only) 27 2700K 30 3000K 35 3500K 40 4000K	WW Wallwash Optic (<19)	IE2 Electronic 2% ELV / TRIAC 220V-240V	W Wallwash Lens

### PART NUMBER NOTES

- CT2 ships as e.g., CT2-AW-1-09BK-90S11A2-W-IE2-WB

### POWDERCOAT FINISHES

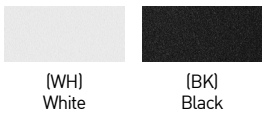

### ALUMINA FINISHES BY LUCIFER LIGHTING™



# TRACK HEAD INT STANDARD STEM CT2 WALLWASH

## WALLWASH DESIGN GUIDE

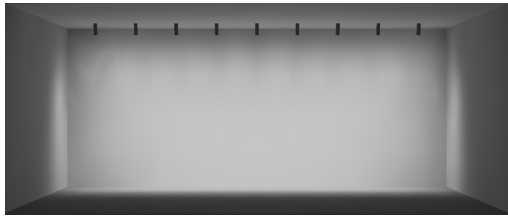

**8FT CEILING**

**36" SETBACK / 36" ON CENTER SPACING / 15° TILT**

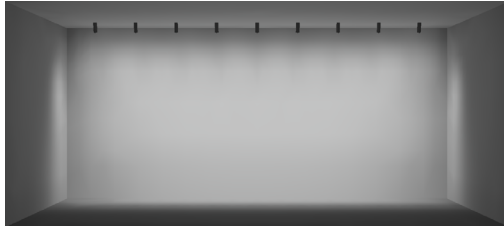

**10FT CEILING**

**36" SETBACK / 36" ON CENTER SPACING / 15° TILT**

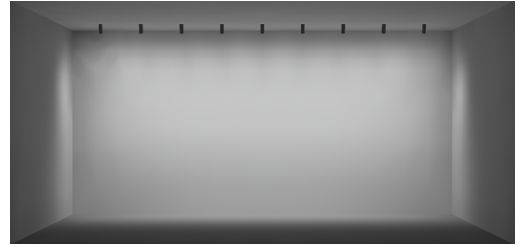

**12FT CEILING**

**36" SETBACK / 36" ON CENTER SPACING / 15° TILT**

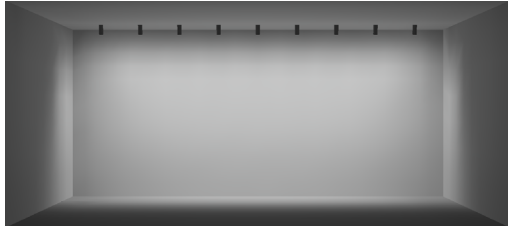

**30" SETBACK / 30" ON CENTER SPACING / 10° TILT**

- AVERAGE FC: 21.92
- MAX / MIN: 4.65
- 10FT CEILING SHOWN / 8-12FT IDEAL
- 9 FIXTURES / 25FT WALL SHOWN

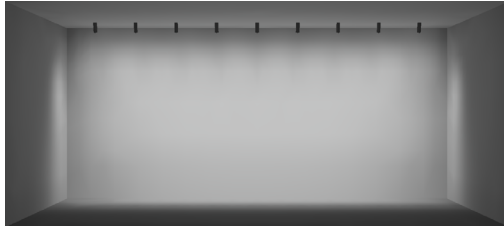

**RECOMMENDED**

**36" SETBACK / 36" ON CENTER SPACING / 15° TILT**

- AVERAGE FC: 20.85
- MAX / MIN: 4.12
- 10FT CEILING SHOWN / 8-12FT IDEAL
- 9 FIXTURES / 30FT WALL SHOWN

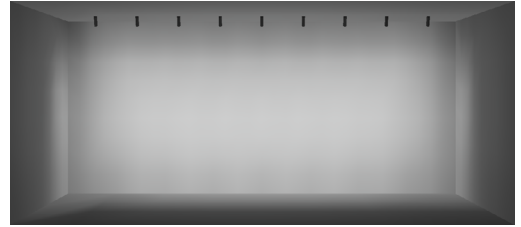

**42" SETBACK / 42" ON CENTER SPACING / 20° TILT**

- AVERAGE FC: 19.23
- MAX / MIN: 5.53
- 10FT CEILING SHOWN / 8-12FT IDEAL
- 9 FIXTURES / 35FT WALL SHOWN

### ADDITIONAL SETBACKS AND SPACINGS

ON CENTER SPACING	SETBACK / TILT		
	30" / 10° TILT	36" / 15° TILT	42" / 20° TILT
30"	SHOWN ABOVE	AVERAGE FC: 23.92 MAX / MIN: 4.51	AVERAGE FC: 25.96 MAX / MIN: 4.54
36"	AVERAGE FC: 19.19 MAX / MIN: 4.37	SHOWN ABOVE	AVERAGE FC: 22.64 MAX / MIN: 4.03
42"	AVERAGE FC: 16.19 MAX / MIN: 5.87	AVERAGE FC: 17.67 MAX / MIN: 5.74	SHOWN ABOVE

# TRACK HEAD INT STANDARD STEM CT2 WALLWASH

## STATIC WHITE PERFORMANCE - 3000K

LUMEN PACKAGE	WATTAGE	WW OPTIC WALLWASH LENS	
		DELIVERED	LPW
80S11A	11	819	74
80S17A	17	1240	73
90S11A	11	704	64
90S17A	17	1065	63
97S11A	11	618	56
97S17A	17	935	55
90W18AL 2700K-1800K	18	787	49
90W18AD 3000K-1800K	18	809	50

### OUTPUT MULTIPLIER

CCT	CCT SCALE
2400K	0.85
2700K	0.97
3000K	1.00
3500K	1.03
4000K	1.08

### UNIFIED GLARE RATING

WALLWASH OPTIC
>19

**Part L** 75+ LPW configurations comply with residential Part L  
95+ LPW configurations comply with commercial Part L

## WARM DIM PERFORMANCE

### INCANDESCENT DIMMING PROFILE

90W18AL 2700K - 1800K	Full on 100%	Dimmed to 80%	Dimmed to 70%	Dimmed to 50%	Dimmed to 20%	Dimmed to 10%	Dimmed to 2%
CCT (K)	2700	2650	2620	2520	2180	1950	1800
Light Output (Lm)	787	630	551	394	157	78.7	16
Power (W)	18	14.4	12.6	9	3.6	1.8	0.36
Efficacy (LPW)	44	44	44	44	44	44	44

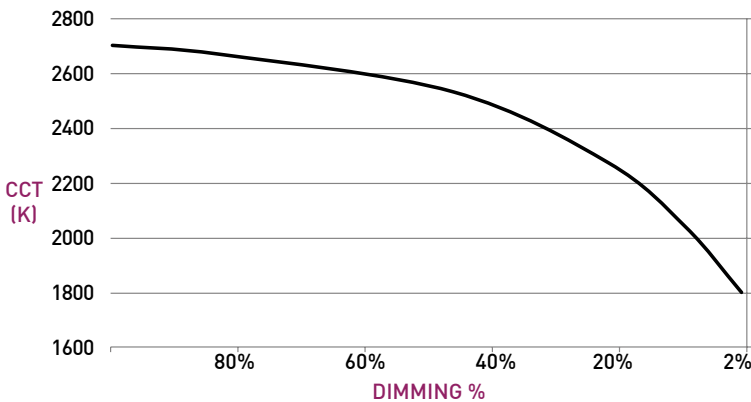

### HALOGEN WARM DIM PROFILE

90W18AD 3000K - 1800K	Full on 100%	Dimmed to 80%	Dimmed to 70%	Dimmed to 50%	Dimmed to 20%	Dimmed to 10%	Dimmed to 2%
CCT (K)	3000	2950	2920	2775	2375	2000	1800
Light Output (Lm)	809	647	566	405	162	81	16
Power (W)	18	14.4	12.6	9	3.6	1.8	0.36
Efficacy (LPW)	43	43	43	43	43	43	43

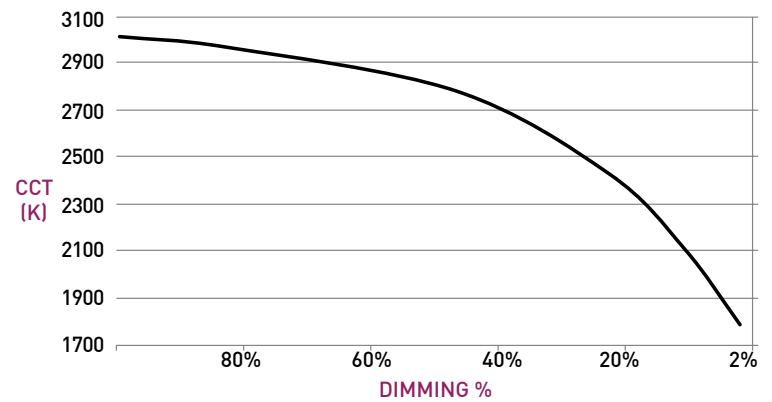

# TRACK HEAD INT STANDARD STEM CT2 WALLWASH

## TRACK HEAD

- A ADJUSTABILITY**  
Power supply integrated into fixture body.  
Up to 90° tilt and 370° rotation.
- B TRACK ADAPTER**  
Proprietary asymmetric track adapter;  
compatible with Lucifer Lighting track only.  
Available in Black and White finishes to  
match track systems.
- C BODY**  
Features integral stem. Available in  
powdercoat and Alumina finishes.
- D KICK REFLECTOR**  
Miro® kick reflector uniformly spreads light  
projected to wall plane.
- E OPTIC**  
Proprietary optic for optimal wallwashing.
- F MEDIA**  
Asymmetrical spread lens, included and  
sealed in place.
- G BAFFLE**  
Baffle minimizes aperture glare and  
conceals view into fixture. Available in black  
powdercoat finish.

## DIMENSIONS / DRAWINGS

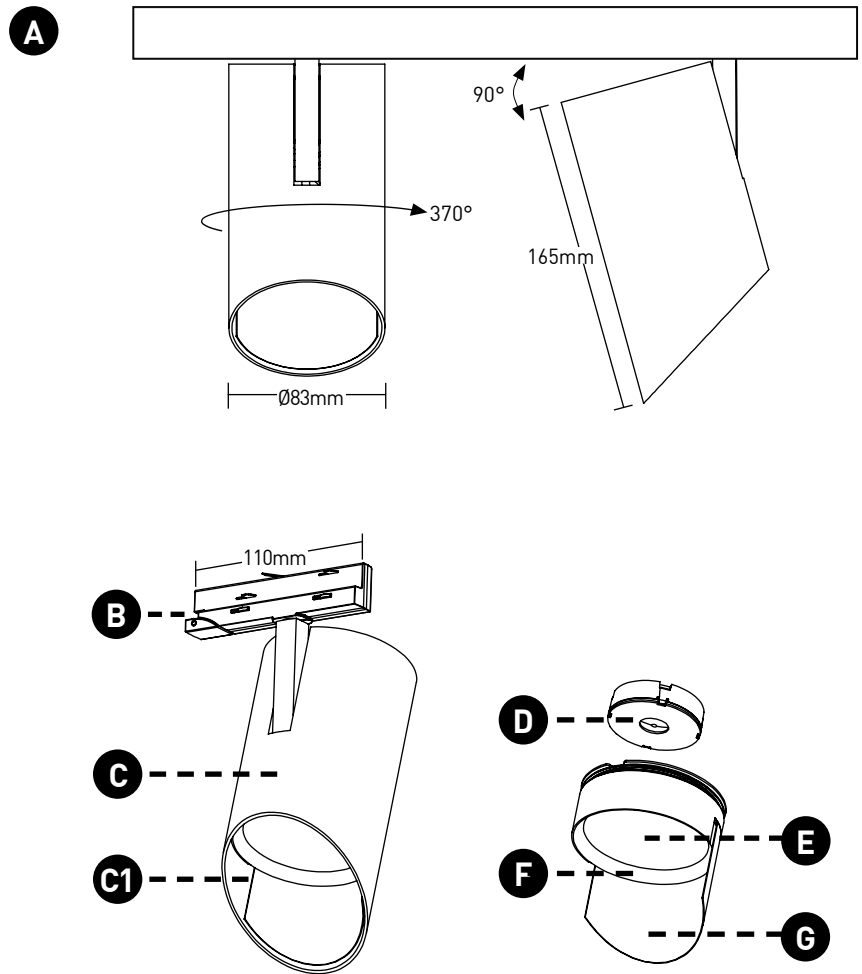

# TRACK HEAD INT STANDARD STEM CT2 WALLWASH

## TECHNICAL

### CONSTRUCTION

**Track Head:** Machined aluminum body; painted finishes are granulated powder coat; Alumina finishes are anodized aluminum.

### STATIC WHITE LED

2-step MacAdam ellipse LED module available in 80+, 90+ and 97+ CRI configurations in color temperatures of 2700K, 3000K, 3500K and 4000K. 3-step MacAdam ellipse LED module available in 90+ CRI configuration in color temperature of 2400K. Average rated lamp life of 50,000 hours.

### WARM DIM LED

3-step MacAdam ellipse warm dim LED module available in 90+ CRI configuration. 3000K or 2700K at full brightness, warming to 1800K at full dim. Average rated lamp life of 50,000 hours.

### POWER SUPPLY PERFORMANCE AND DIMMING INFORMATION

Power Supply	IE2
Minimum °C	-20 °C
Maximum °C	40 °C
Dimming %	2.0%

### MOUNTING

Cylinder track head mounts to recessed, surface or pendant mount track assemblies, specified separately.

### SPACING AND TILT

Trackhead must be tilted to achieve wallwashing effect. Recommended fixture spacing is 914mm (36") on center with 914mm (36") setback from wall plane with 15° tilt.

### LISTING

Track heads and drivers CE Listed for dry locations. Drivers ENEC and CB Listed.

### PART L

Part L compliant for all 75+ LPW residential and 95+ LPW commercial configurations.

### LIMITED WARRANTY

Manufacturer's Limited Warranty guarantees product(s) listed to be free from defects in material and workmanship under normal use and service for 1-year. LED and power supplies are warranted to operate with 70% of original flux and remain within a range of 3 duv for a period of 5-years. Warranty period begins from the date of shipment by Seller. [Consult website for full warranty terms and conditions.](#)

### CHANGE LOG

- 10/17/2022: REMOVED CE2 DRIVER AND ADDED CE3 DRIVER.
- 05/12/2023: ADDED LBC RED LIST APPROVED.
- 08/08/2023: ADDED NEW LED AND OPTIC SYSTEM.
- 02/08/2024: ADDED 2400K OFFERING.
- 2/15/2024: PART L COMPLIANCE ADDED