

CYLINDER 2 INTERNATIONAL SUSPENDED STEM DROPKIT

Our best-selling cylinders keep getting better. Suspended cylinders are offered in a broad range of sizes and more than a dozen finish options, with field-cutttable stems and lumens from 800 to almost 4000lm.

PROJECT NAME:	TYPE:
---------------	-------

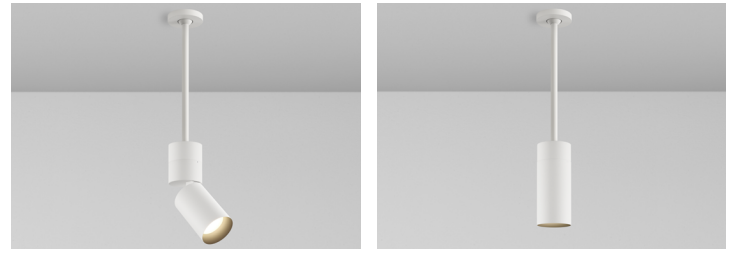

ORDERING INFORMATION

CYLINDER	LENGTH	FUNCTION	RATING	CYLINDER FINISH	BAFFLE FINISH	CRI / WATTAGE PACKAGE	CCT	OPTIC (UGR)	MEDIA	POWER SUPPLY	MOUNTING			
CD2X			1								EXMP			
Dropkit® STEM ASSEMBLY CD2X 79mm Ø	043 2" - 43" Mechanical Dropkit Stem	AD 90° Adjustable AS 90° Adjustable Shallow Canopy* *(Remote driver only)	1 Dry / Damp (IP30)	POWDERCOAT FINISHES WH White AG Satin Silver AU Cashmere Gold AB Architectural Bronze BB Burnt Bronze BK Black CF Custom Finish* *(Consult Factory)	POWDERCOAT FINISHES WH White AG Satin Silver AU Cashmere Gold AB Architectural Bronze BB Burnt Bronze BK Black CF Custom Finish* *(Consult Factory)	STATIC WHITE 80S11B 80+ CRI, 11 Watts 1111 lm delivered 80S17B 80+ CRI, 17 Watts 1613 lm delivered 80S23B 80+ CRI, 23 Watts 2293 lm delivered 90S11B 90+ CRI, 11 Watts 950 lm delivered 90S17B 90+ CRI, 17 Watts 1475 lm delivered 90S23B 90+ CRI, 23 Watts 1960 lm delivered 97S11B 97+ CRI, 11 Watts 874 lm delivered 97S17B 97+ CRI, 17 Watts 1357 lm delivered 97S23B 97+ CRI, 23 Watts 1803 lm delivered	24 2400K* *(90+CRI only, 17W max) 27 2700K 30 3000K 35 3500K 40 4000K	10 10°* (<13) *(17 Watts only) 15 15° (<13) 20 20° (<10) 25 25° (<10) 40 40° (<10) 60 60° (<16) WW Wallwash* *(Required for WW & AW fixture)	STANDARD MEDIA 4 Soft Focus Lens (SFL)* *(Required for 10° optic) ALTERNATE MEDIA 0 No Lens* *(Not available for Warm Dim) 2 Honey Comb Louver (HCL)* *(Not available for Warm Dim) 3 Clear Glass Lens (CGL)* *(Not available for Warm Dim) 5 Frosted Glass Lens (FGL) 6 Frosted Soft Focus Lens (FSFL)	INTEGRAL 2IE Electronic Forward / Reverse 220V-240V REMOTE (220-277V) 2EG eldoLED, SOLOdrive 0.1% 0-10V, LOG 2EN eldoLED, SOLOdrive 0.1% 0-10V, LIN 2ED eldoLED, SOLOdrive 0.1% DALI, LOG 2LD eldoLED, SOLOdrive 0.1% DALI, LIN	EXMP Export Mounting Plate Features 89mm diameter canopy			
	086 45" - 86" Mechanical Dropkit Stem	AW Adjustable Wallwash FB Fixed		ALUMINA CONSULT FACTORY FOR ALUMINA FINISHES ALUMINA CONSULT FACTORY FOR ALUMINA FINISHES	WARM DIM 90W24B 90+ CRI, 24 Watts Incandescent Profile 1469 lm delivered Standard Profile 1698 lm delivered *SEE PAGE 4 FOR DETAILED PERFORMANCE CONFIGURATIONS AND WARM DIM PROFILE COMPARISON.	WL 2700K - 1800K WD 3000K - 1800K WW Wallwash* *(Required for WW & AW fixture)	20 20° (<10) 25 25° (<10) 40 40° (<10) 60 60° (<13)	7 Frosted Linear Spread Lens (FLSL) C Clear Glass Film w/ Honeycomb Louver S Soft Focus Film w/ Honeycomb Louver	TUNABLE WHITE REMOTE (220-277V) 2DD eldoLED, DUALdrive 0.1% DALI, LOG					
	129 88" - 129" Mechanical Dropkit Stem	WW Wallwash Fixed			TUNABLE WHITE (REMOTE DRIVER ONLY) 90T32B 90+ CRI, 32 Watts Warm Profile Lm. Deliered - 2430 Cool Profile 2277 lm delivered	TR 4000K - 1800K TH 5000K - 2700K WW Wallwash* *(Required for WW & AW fixture)	15 15° (<13) 20 20° (<10) 25 25° (<10) 40 40° (<10) 60 60° (<13)	W Wallwash Lens* *(Required for WW and AW fixture)						
	172 131" - 172" Mechanical Dropkit Stem													
	*All lengths are field cuttable)													
	*SEE PAGE 4 FOR DETAILED PERFORMANCE CONFIGURATIONS AND WARM DIM PROFILE COMPARISON.													
	*ALL DELIVERED LUMEN OUTPUTS REFLECT 3000K PAIRED WITH 20° OPTIC AND SOFT FOCUS LENS.													
	*SEE PAGE 4 FOR UGR VALUES													

PART NUMBER NOTES

- CD2X Cylinder ships as e.g., CY2XAD1WHWH80S17A304042EA2
- Stem Assembly ships as CY2X-DK-[length]-[finish]
- Remote driver ships as e.g., PS-RMT-80S17A-2EG2

CYLINDER 2 INTERNATIONAL SUSPENDED STEM DROPKIT

ACCESSORIES

REPLACEMENT MEDIA

- SFL-CY2X-03** Soft Focus Lens
- HCL-CY2X-03** Honeycomb Louver *
*(Not available for Warm Dim)
- CGL-CY2X-03** Clear Glass Lens *
*(Not available for Warm Dim)
- FGL-CY2X-03** Frosted Glass Lens
- FSFL-CY2X-03** Frosted Soft Focus Lens
- FLSL-CY2X-03** Frosted Linear Spread Lens
- CGL-HCL-CY2X-03** Clear Glass Film W/ Honeycomb Louver
- SFL-HCL-CY2X-03** Soft Focus Film W/ Honeycomb Louver

Dropkit STEM EXTENSION

- RPS-DK-EXT-**** 2-42" Stem Extension
- ** Stem finish: Specify **WH** for white, **AG** for satin Silver, **AU** for cashmere gold, **AB** for architectural bronze, **BB** for burnt bronze, or **BK** for black.

STATIC WHITE REPLACEMENT OPTICS

- RO-70-15-S** 15° optic
- RO-70-20-S** 20° optic
- RO-70-25-S** 25° optic
- RO-70-40-S** 40° optic
- RO-70-60-S** 60° optic

WARM DIM REPLACEMENT OPTICS

- RO-70-20-W** 20° optic
- RO-70-25-W** 25° optic
- RO-70-40-W** 40° optic
- RO-70-60-W** 60° optic

TUNABLE WHITE REPLACEMENT OPTICS

- RO-70-15-T** 15° optic
- RO-70-20-T** 20° optic
- RO-70-25-T** 25° optic
- RO-70-40-T** 40° optic
- RO-70-60-T** 60° optic

SUCTION CUP TOOL

- CYX-TOOL-SUCTION** Baffle removal tool, provided with every 5 fixtures

EMERGENCY LIGHTING - REMOTE MOUNT ONLY

During disruption of main power, emergency battery inverter provides temporary 120V or 277V to fixture.

- EMB-S-25-120/277-LEDX** 25 watt max capacity, 120 or 277 VAC 60Hz
- EMB-S-100-120-LEDX** 100 watt max capacity, 120 VAC 60Hz, 0-10V dimmable
- EMB-S-100-277-LEDX** 100 watt max capacity, 277 VAC 60Hz, 0-10V dimmable
- EMB-S-250-120/277-LEDX** 250 watt max capacity, 120 or 277 VAC 60Hz

***SHUNT REQUIRED FOR USE WITH ATHENA AND CASAMBI CONTROLS, CONSULT FACTORY FOR DETAILS.**

POWDERCOAT FINISHES

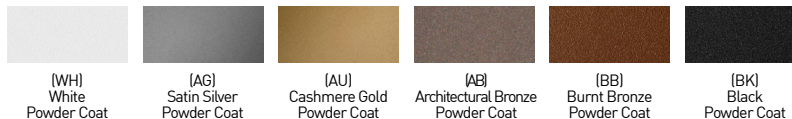

ALUMINA FINISHES BY LUCIFER LIGHTING™



CYLINDER 2 INTERNATIONAL SUSPENDED STEM DROPKIT

WALLWASH DESIGN GUIDE

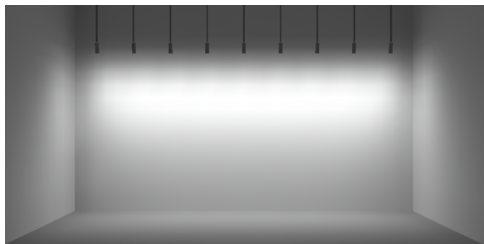

10° TILT

30" SETBACK / 30" ON CENTER SPACING

- 10FT CEILING SHOWN / 8-12FT IDEAL
- AVERAGE FC: 33.74
- MAX / MIN: 4.89
- 9 FIXTURES / 25FT WALL SHOWN



RECOMMENDED

15° TILT

36" SETBACK / 36" ON CENTER SPACING

- 10FT CEILING SHOWN / 8-12FT IDEAL
- AVERAGE FC: 30.07
- MAX / MIN: 4.35
- 9 FIXTURES / 25FT WALL SHOWN

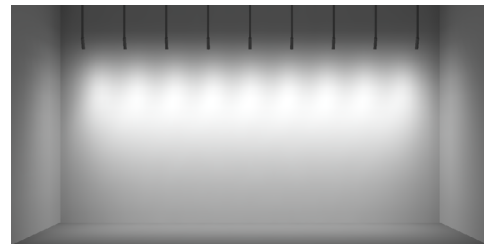

20° TILT

42" SETBACK / 42" ON CENTER SPACING

- 10FT CEILING SHOWN / 8-12FT IDEAL
- AVERAGE FC: 27.25
- MAX / MIN: 4.07
- 9 FIXTURES / 25FT WALL SHOWN

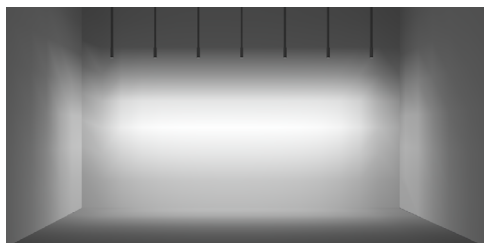

30" SETBACK / 42" ON CENTER SPACING

- 10FT CEILING SHOWN / 8-12FT IDEAL
- AVERAGE FC: 25.44
- MAX / MIN: 6.25
- 9 FIXTURES / 25FT WALL SHOWN

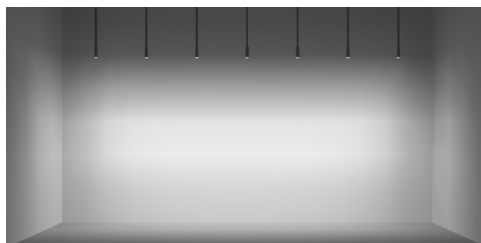

RECOMMENDED

36" SETBACK / 48" ON CENTER SPACING

- 10FT CEILING SHOWN / 8-12FT IDEAL
- AVERAGE FC: 20.44
- MAX / MIN: 6.06
- 9 FIXTURES / 30FT WALL SHOWN



42" SETBACK / 54" ON CENTER SPACING

- 10FT CEILING SHOWN / 8-12FT IDEAL
- AVERAGE FC: 16.48
- MAX / MIN: 6.24
- 9 FIXTURES / 35FT WALL SHOWN

ADDITIONAL SETBACKS AND SPACINGS

ON CENTER SPACING	SETBACK / TILT			ON CENTER SPACING	SETBACK		
	30" / 10°	36" / 15°	42" / 20°		30"	36"	42"
30"	SHOWN ABOVE	AVERAGE FC: 35.46 MAX / MIN: 4.37	AVERAGE FC: 36.51 MAX / MIN: 4.12	42"	SHOWN ABOVE	AVERAGE FC: 22.85 MAX / MIN: 6.30	AVERAGE FC: 20.41 MAX / MIN: 6.41
36"	AVERAGE FC: 28.80 MAX / MIN: 4.98	SHOWN ABOVE	AVERAGE FC: 31.27 MAX / MIN: 4.04	48"	AVERAGE FC: 22.75 MAX / MIN: 6.02	SHOWN ABOVE	AVERAGE FC: 18.24 MAX / MIN: 6.19
42"	AVERAGE FC: 25.13 MAX / MIN: 5.20	AVERAGE FC: 26.20 MAX / MIN: 4.42	SHOWN ABOVE	54"	AVERAGE FC: 20.53 MAX / MIN: 6.11	AVERAGE FC: 18.44 MAX / MIN: 6.09	SHOWN ABOVE

***ALL DATA REFLECTS 90S17A WATTAGE PACKAGE**

CYLINDER 2 INTERNATIONAL SUSPENDED STEM DROPKIT

STATIC WHITE PERFORMANCE - 3000K

LUMEN PACKAGE	WATTAGE	10° OPTIC FIELD REDUCER		15° OPTIC SOFT FOCUS LENS		20° OPTIC SOFT FOCUS LENS		25° OPTIC SOFT FOCUS LENS		40° OPTIC SOFT FOCUS LENS		60° OPTIC SOFT FOCUS LENS		WALLWASH WALLWASH LENS		ADJ. WALLWASH WALLWASH LENS	
		DLVD	LPW	DLVD	LPW	DLVD	LPW	DLVD	LPW	DLVD	LPW	DLVD	LPW	DLVD	LPW	DLVD	LPW
80S11B	11	-	-	1095	99	1151	104	1151	104	1073	97	1018	92	706	64	917	83
80S17B/C	17	779	46	1651	97	1768	103	1789	105	1654	97	1583	93	1094	64	1416	83
80S23B	23	-	-	2201	95	2360	102	2374	103	2201	95	2112	91	1452	63	1884	81
90S11B	11	-	-	936	85	984	89	984	89	917	83	870	79	603	54	784	71
90S17B/C	17	671	39	1411	83	1511	88	1529	89	1414	83	1353	79	935	55	1210	71
90S23B	23	-	-	1881	81	2017	87	2029	88	1882	81	1805	78	1241	53	1610	70
97S11B	11	-	-	861	78	905	82	905	82	844	76	800	72	555	50	721	65
97S17B/C	17	579	34	1298	76	1390	81	1407	82	1301	76	1245	73	860	50	1113	65
97S23B	23	-	-	1731	75	1856	80	1867	81	1731	75	1661	72	1442	49	1481	64
90W24BL (2700K-1800K)	24	-	-	-	-	1530	63	1516	63	1425	59	1344	56	1137	47	1238	51
90W24BD (3000K-1800K)	24	-	-	-	-	1592	66	1582	65	1495	62	1419	59	1267	52	1305	54
90T32BTR (4000K-1800K)	32	-	-	2360	73	2472	77	2468	77	2326	72	2224	69	1669	52	2035	63
90T32BTH (5000K-2700K)	32	-	-	2254	70	2351	72	2334	71	2208	67	2105	59	1848	57	1910	59

MEDIA LIGHT LOSS FACTOR

MEDIA	LIGHT LOSS FACTOR
No Lens	1.07
CGL	0.98
SFL	1.00
FGL	0.94
FSFL	0.93
FLSL	0.85
HCL	0.72
SFL+HCL	0.66

OUTPUT MULTIPLIER

CCT	CCT SCALE
2400K	0.76
2700K	0.957
3000K	1.000
3500K	1.019
4000K	1.030

TUNABLE WHITE MULTIPLIER

CCT	5000K-2700K	4000K-1800K
5000K	1.16	-
4000K	1.08	1.14
3500K	1.04	1.07
3000K	1.00	1.00
2700K	0.96	0.92
2400K	-	0.84
1800K	-	0.69

Part L 75+ LPW configurations comply with residential Part L
95+ LPW configurations comply with commercial Part L

UNIFIED GLARE RATING

10° OPTIC FIELD REDUCER	15° OPTIC SOFT FOCUS LENS	20° OPTIC SOFT FOCUS LENS	25° OPTIC SOFT FOCUS LENS	40° OPTIC SOFT FOCUS LENS	60° OPTIC SOFT FOCUS LENS	WALLWASH WALLWASH LENS
<13	<13	<10	<10	<10	<16	>19

WARM DIM PERFORMANCE - SOFT FOCUS LENS - 20° OPTIC

INCANDESCENT DIMMING PROFILE

90W24BL 2700K - 1800K	Full on 100%	Dimmed to 80%	Dimmed to 70%	Dimmed to 50%	Dimmed to 20%	Dimmed to 10%	Dimmed to 2%
CCT (K)	2700	2650	2620	2520	2180	1950	1800
Light Output (Lm)	1530	1224	1071	765	306	153	31
Power (W)	24	19	17	12	5	2.4	0.5
Efficacy (LPW)	63	63	63	63	63	63	63

STANDARD DIMMING PROFILE

90W24BD 3000K - 1800K	Full on 100%	Dimmed to 80%	Dimmed to 70%	Dimmed to 50%	Dimmed to 20%	Dimmed to 10%	Dimmed to 2%
CCT (K)	3000	2950	2920	2775	2375	2000	1800
Light Output (Lm)	1592	1274	1114	796	318	159	32
Power (W)	24	19	17	12	5	2.4	0.5
Efficacy (LPW)	66	66	66	66	66	66	66

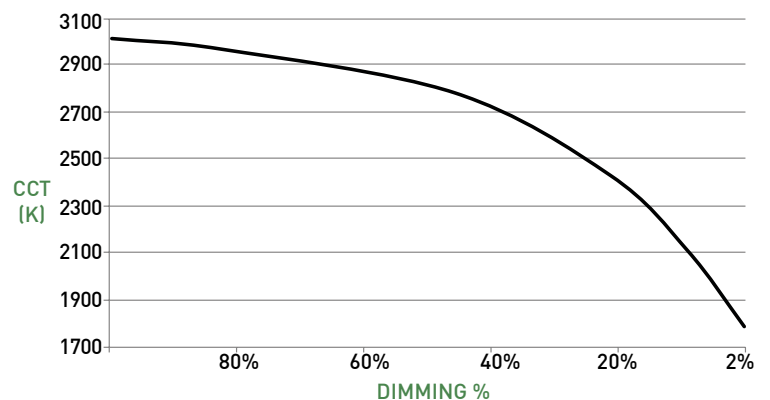
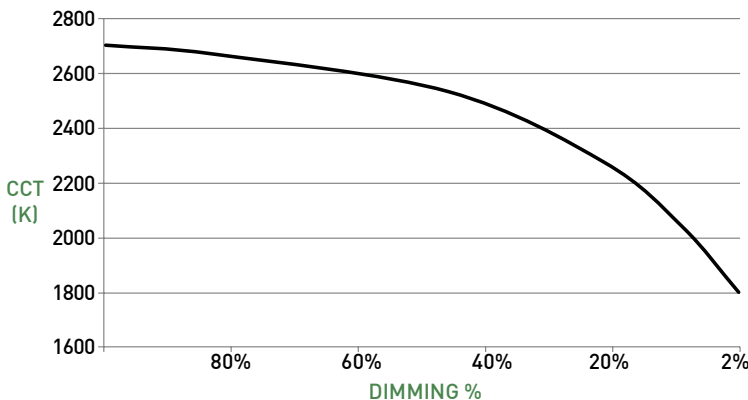

CYLINDER 2 INTERNATIONAL SUSPENDED STEM DROPKIT

CYLINDER ASSEMBLY

- A EXPORT MOUNTING PLATE**
Export mounting plate (concealed) to be installed above ceiling substrate. Features minimalist 89mm diameter canopy.
- B ADJUSTABLE - STANDARD CANOPY**
Die-cast canopy accommodates flat and sloped ceiling conditions. Conceals hidden mounting hardware. "AD" (90° tilt, 365° rotation) canopy features 1.90" (48mm) tall canopy. Available with integral or remote driver.
- C ADJUSTABLE - SHALLOW CANOPY**
Die-cast canopy accommodates flat and slope ceiling conditions. Conceals hidden mounting hardware. "AS" (90° tilt, 365° rotation) canopy features 0.65" (17mm) tall canopy, reducing overall height. Requires remote power supply.
- D FIXED BODY**
Body with integrated heat sink and LED. Conceals mounting hardware. Power supply may be integral or remote mount.
- E WALLWASH FIXED BODY**
- F1 OPTICS**
Robust light engine with optimized optic pairing integrates Reflection, Refraction, and TIR offering 10°, 15°, 20°, 25°, 40° & 60° beams.
- F2 10° FIELD REDUCER**
Included with 10° optic. Reduces field angle by 56%
- G MEDIA**
Cylinder accepts 2 lenses; soft focus lens, no lens or wallwash lens standard. Sealed in place for Wet locations.
- H BAFFLE**
Die-cast baffle minimizes aperture glare and conceals view into fixture.
- I DROPKIT**
 - Field cuttable rigid stem for suspending fixture at desired height. Provides stable base to allow preferred fixture tilt, while maintaining vertical stem position.
 - Ball joint allows up to 45° tilt for sloped ceilings and can be locked once stem is positioned vertically.
 - Four 43" sections available; 172" maximum standard length.
 - Length adjustment occurs in lower canopy.
 - Wiring for kit provided by others.

DIMENSIONS / DRAWINGS

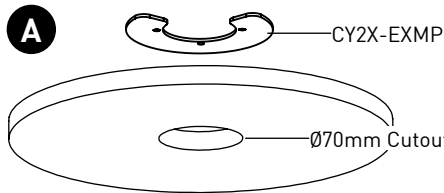

B ADJUSTABLE BODY STANDARD CANOPY

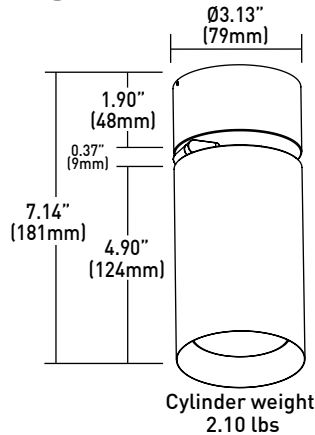

C ADJUSTABLE BODY SHALLOW CANOPY

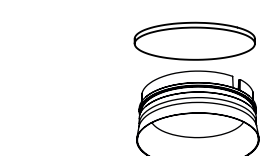
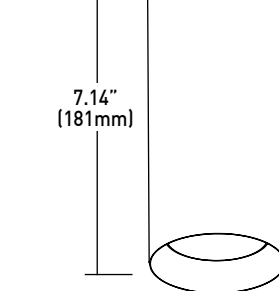
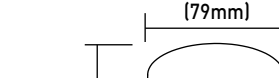
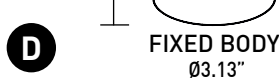
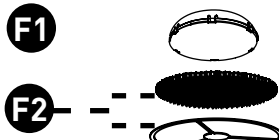
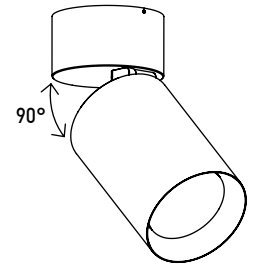
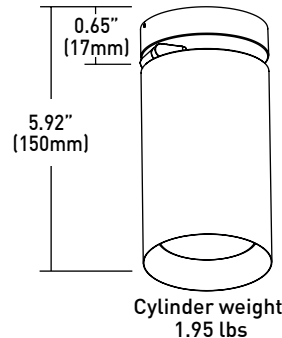

E WALLWASH FIXED BODY

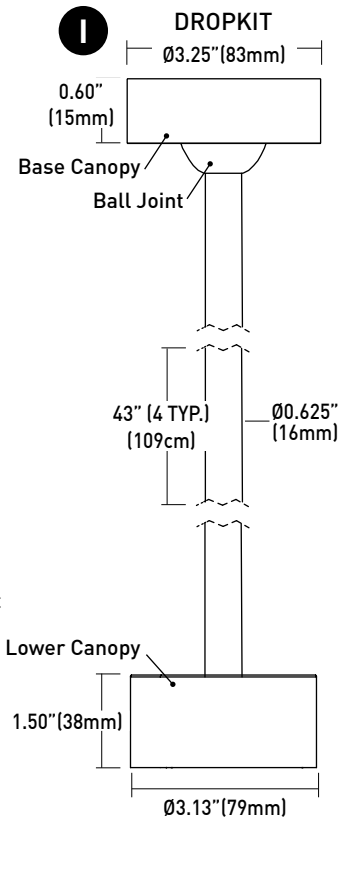
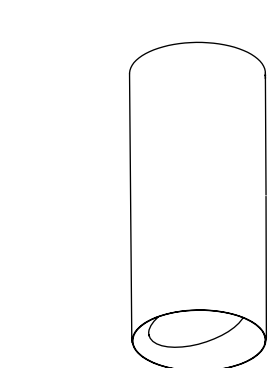

REMOTE POWER SUPPLY

- J** Remote power supply provides additional driver options. See page 6 for maximum allowable wiring distance. Must be installed in an accessible location.

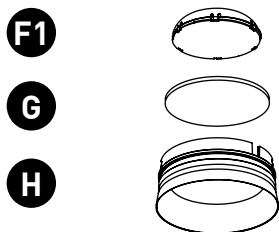
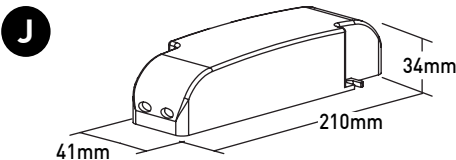

CYLINDER 2 INTERNATIONAL SUSPENDED STEM DROPKIT

TECHNICAL

CONSTRUCTION

Cylinder: Die-cast aluminum body with integrated heat sink; painted finishes are granulated powder coat. Alumina finishes are anodized aluminum.

Dropkit Stem Assembly: Die-cast aluminum canopies and extruded aluminum stems; painted finishes are granulated powder coat.

Remote Power Supply: 22 Gauge galvanized steel.

STATIC WHITE LED

2-step MacAdam ellipse LED module available in 80+, 90+ and 95+ CRI configurations in color temperatures of 2700K, 3000K, 3500K and 4000K. 3-step MacAdam ellipse LED module available in 90+ CRI configuration in color temperature of 2400K. Average rated lamp life: 50,000 hours. LED and driver assemblies are field-replaceable.

WARM DIM LED

3-step MacAdam ellipse warm dim LED module available in 90+ CRI configuration. 3000K or 2700K at full brightness, warming to 1800K at full dim. Average rated lamp life of 50,000 hours. LED and driver assemblies are field-replaceable.

TUNABLE WHITE LED

3-Step MacAdam ellipse tunable white LED module available in 90+ CRI configuration. Features tuning range of 2700K to 5000K and 1800K to 4000K. Average rated lamp life of 50,000 hours. Driver assemblies are field-replaceable.

POWER SUPPLY PERFORMANCE AND DIMMING INFORMATION

Power Supply	PHASE			0-10V			DALI		
	2IE	2EG	2EN	2ED	2LD	2DD			
Minimum °C	-20 °C	-20 °C	-20 °C	-20 °C	-20 °C	-20 °C			
Maximum °C	40 °C	40 °C	40 °C	40 °C	40 °C	40 °C			
Dimming %	2.0%	0.1%	0.1%	0.1%	0.1%	0.1%			

Note: For EG and EN drivers consult chart on page 7 to confirm appropriate dimming curve for compatibility with selected control.

MAXIMUM ALLOWABLE REMOTE DRIVER WIRING DISTANCES

DRIVER	WIRE AWG				
	12	14	16	18	20
2EG, 2EN, 2ED, 2LD, 2DD	-	-	118'	72'	46'

WALLWASH SPACING AND TILT

Adjustable Wallwash Cylinder must be tilted to achieve wallwashing effect. Recommended adjustable spacing is 36" (914mm) on center with 36" (914mm) setback from wall plane with 15° tilt. Recommended fixed spacing is 36" (914mm) on center spacing with 48" (1219mm) setback from wall plane.

LISTING

Cylinders and drivers CE Listed for Dry / Damp locations. Integral drivers ENEC and CB Listed.

DECLARE

LBC Red List Approved.

PART L

Part L compliant for all 75+ LPW residential and 95+ LPW commercial configurations.

WARRANTY

Manufacturer's 1-year warranty guarantees product(s) listed to be free from defects in material and workmanship under normal use and service. 5-year warranty on LED and power supply to operate with 70% of the original flux and remain within a range of 3 duv. 10-year Lutron Advantage limited warranty available on Lutron equipped systems. Warranty period begins from the date of shipment by Seller. Consult [website](#) for full warranty terms and conditions.

CHANGE LOG

- 2/15/2024: PART L COMPLIANCE ADDED
- 3/15/2024: 10 DEGREE FIELD REDUCER ADDED, 10 DEGREE PERFORMANCE DATA UPDATED

CYLINDER 2 INTERNATIONAL SUSPENDED STEM DROPKIT

DIMMING COMPATIBILITY

eldoLED DRIVER COMPATIBILITY

Power supply EG Manufacturer	Family/Model #
Busch-Jaeger	2112U-101
Jung	240-10
Leviton Lighting Controls	IP710-DLX
Lightolier Controls	ZP600FAM120
Merten	5729
Pass & Seymour	CD4FB-W
The Watt Stopper	DCLV1
Synergy	ISD BC
Crestron®	GLX-DIMFLV8
Crestron®	GLXP-DIMFLV8
Crestron®	GLPAC-DIMFLV4-*
Crestron®	GLPAC-DIMFLV8-*
Crestron®	GLPP-DIMFLVEX-PM
Crestron®	GLPP-1DIMFLV2EX-PM
Crestron®	GLPP-1DIMFLV3EX-PM
Crestron®	DIN-A08
Crestron®	DIN-4DIMFLV4
Crestron®	CLS-EXP-DIMFLV
Crestron®	CLCI-1DIMFLV2EX
Power supply EN Manufacturer	Family/Model #
Lutron Electronics	Nova T® - NTFTV
Lutron Electronics	Diva® - DDTV
Lutron Electronics	Nova® - NFTV
Lutron Electronics	GrafixEye® GRX-TVI w GRX3503
Lutron Electronics	Energy Savr Node™ - QSN-4T16-S
Lutron Electronics	TVM2 Module
Sensor Switch	nIO EZ
ABB	SD/S 2.16.1

ANALOG DRIVERS AND DIMMERS

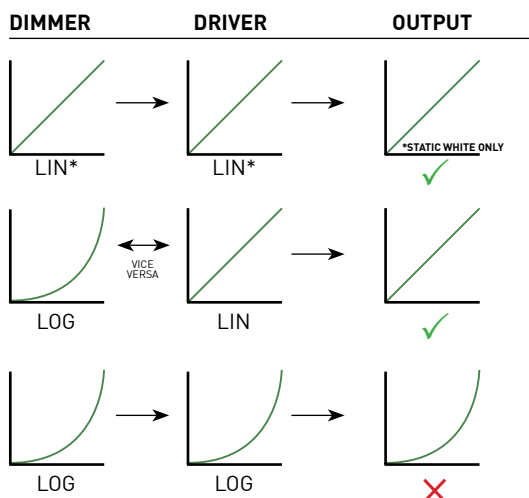

LIN = LINEAR

LOG = LOGARITHMIC

*LIN-TO-LIN NOT COMPATIBLE FOR WARM DIM