

# CYLINDER 3 FIXED SUSPENDED MOUNT

Highlight art, objects, places, spaces, seating areas, and architectural details with a classic profile that offers easy-to-adjust, in-field versatility.

PROJECT NAME:	TYPE:
---------------	-------

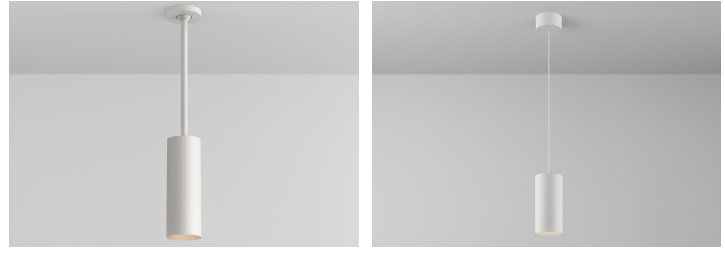

## ORDERING INFORMATION - CYLINDER

Quick Ship Product. All rough in components ship within 10 days up to quantities of 100.

CYLINDER	LENGTH	FIXTURE	RATING	CYLINDER FINISH	BAFFLE FINISH	LUMEN PACKAGE	CCT	OPTIC	DRIVER	EFFECTS DEVICE	MOUNTING
			<b>1</b>						<b>LVS</b>		
<b>Dropkit® STEM ASSEMBLY</b> <b>CD3</b> 3.25"	<b>043</b> 2" - 43" Mechanical Dropkit Stem	<b>FB</b> Fixed Body <b>WW</b> Wallwash Unibody	1 Dry / Damp	<b>WH</b> White <b>AG</b> Satin Silver* <small>*(Increased lead time)</small> <b>AB</b> Architectural Bronze* <small>*(Increased lead time)</small> <b>BK</b> Black <b>CF</b> Custom Finish* <small>*(Consult Factory)</small>	<b>WH</b> White <b>AG</b> Satin Silver* <small>*(Increased lead time)</small> <b>AB</b> Architectural Bronze* <small>*(Increased lead time)</small> <b>BK</b> Black <b>CF</b> Custom Finish* <small>*(Consult Factory)</small>	<b>LOW FLUX STATIC WHITE</b> <b>80C19A</b> 80+ CRI FB Dlvd. Lumens - 1127 WW Dlvd. Lumens - 1280 <b>80C25A</b> 80+ CRI FB Dlvd. Lumens - 1502 WW Dlvd. Lumens - 1699 <b>90C15A</b> 90+ CRI FB Dlvd. Lumens - 905 WW Dlvd. Lumens - 1096 <b>90C20A</b> 90+ CRI FB Dlvd. Lumens - 1287 WW Dlvd. Lumens - 1456 <b>97C14A</b> 97+ CRI FB Dlvd. Lumens - 863 WW Dlvd. Lumens - 980 <b>97C19A</b> 97+ CRI FB Dlvd. Lumens - 1151 WW Dlvd. Lumens - 1317	<b>22</b> 2200K* <small>*(Only available for 90+ CRI)</small> <b>27</b> 2700K <b>30</b> 3000K <b>35</b> 3500K <b>40</b> 4000K	<b>10</b> 10°* <small>*(Only available for 80C19A, 90C15A, and 97C14A. Not available for 2200K)</small> <b>15</b> 15° <b>25</b> 25° <b>40</b> 40° <b>60</b> 60° <b>WW</b> Wall wash* <small>*(Required and only available for WW fixture)</small>	<b>LVS</b> Low Voltage System	<b>STANDARD EFFECTS DEVICE</b> <b>4</b> Soft Focus Lens <b>N</b> No Lens* <small>*(Standard for 10" optic. Not available for Warm Dim)</small> <b>W</b> Wallwash Lens* <small>*(Required and only available for WW fixture)</small> <b>ALTERNATE EFFECTS DEVICE</b> <b>2</b> Honeycomb Louver* <small>*(Not available for Warm Dim)</small> <b>3</b> Clear Glass Lens* <small>*(Not available for Warm Dim)</small> <b>5</b> Frosted Glass Lens <b>6</b> Frosted Soft Focus Lens <b>7</b> Frosted Linear Spread Lens <b>5</b> Soft Focus Lens w/ Linear Spread Film <b>C</b> Clear Glass Lens w/ Linear Spread Film	<b>ROUGH-IN</b> <b>JBMP</b> 4" Sq. or 4/0 Junction Box Mounting Plate <b>FINISH OUT</b> <b>SMK3</b> 3/0 Surface Mount Kit <b>SMK4</b> 4/0 Surface Mount Kit <b>CMJB</b> 1/2" and 3/4" Conduit Ceiling Mount Junction Box* <small>*(Not available for MA finish. Quick Ship Product for WH and BK finishes only)</small>
	<b>PENDANT</b> <b>CP3</b> 3.25"	<b>XXXB</b> Black Cable <b>XXXW</b> White Cable Specify cable length in whole inches (Max 180) ex. specify 006B for a 6 inch black cable* <small>*(Cable is field cuttable)</small>	<b>FB</b> Fixed Body	1 Dry / Damp	<b>WH</b> White <b>AG</b> Satin Silver* <small>*(Increased lead time)</small> <b>AB</b> Architectural Bronze* <small>*(Increased lead time)</small> <b>BK</b> Black <b>MA</b> Machined Aluminum* <small>*(Not available with 9D, 9S, or Wet location)</small> <b>CF</b> Custom Finish* <small>*(Consult Factory)</small>	<b>BK</b> Black	<b>HIGH FLUX STATIC WHITE</b> <b>80C32A</b> 80+ CRI FB Dlvd. Lumens - 1961 WW Dlvd. Lumens - 2218 <b>90C27A</b> 90+ CRI FB Dlvd. Lumens - 1680 WW Dlvd. Lumens - 1834 <b>97C24A</b> 97+ CRI FB Dlvd. Lumens - 1503 WW Dlvd. Lumens - 1706  <b>WARM DIM</b> <b>90W11A</b> 90+ CRI, Incandescent Profile FB Dlvd. Lumens - 941 WW Dlvd. Lumens - 813  <b>90W12A</b> 90+ CRI, Standard Profile FB Dlvd. Lumens - 991 WW Dlvd. Lumens - 1013  <small>*SEE PAGE 3 FOR DETAILED WARM DIM PROFILE COMPARISON.</small>  <small>*ALL DELIVERED LUMEN OUTPUTS REFLECT 3000K PAIRED WITH 60° / WW OPTIC AND STANDARD EFFECTS DEVICE.</small>	<b>27</b> 2700K <b>30</b> 3000K <b>35</b> 3500K* <small>*(Not available for 97+ CRI)</small> <b>40</b> 4000K	<b>15</b> 15° <b>25</b> 25° <b>40</b> 40° <b>60</b> 60° <b>WW</b> Wall-wash* <small>*(Required and only available for AW fixture)</small>  <b>25</b> 25° <b>40</b> 40° <b>60</b> 60° <b>WW</b> Wall-wash* <small>*(Required and only available for AW fixture)</small>		



## PART NUMBER NOTES



- CD3 Adjustable ships as e.g., CY3-AD-1-WH-90C20A2-3-LVS-4
- Stem Assembly ships as CY3-DK-(length)-(finish)
- CP3 ships as e.g., CP3-1-180-WH-90C20A2-3-LVS-4-W
- Mounting ships separate from fixture, part numbers listed on page 8.

# CYLINDER 3 LVS FIXED SUSPENDED MOUNT

## APPLICATION NOTES

- Lucifer Lighting will not supply a fixture with a POE node or power supply inside the fixture. This allows for easier site install with nodes of 2 or more outputs.
- Consult node manufacturer for maximum remote wiring distances.
- Fixture features 18 Gauge wiring.
- Wiring connections are made on the fixture using customer supplied connectors, ex. wire nuts, push-in connectors, or terminal blocks.
- Confirm node compatibility with factory if it is not listed.
- Customers are responsible for ensuring POE node drive current is set to correct values shown below.
- Customers must ensure voltage range of the proposed POE node encompasses the fixtures complete Vf range, both maximum and minimum. If assistance is required contact LLC rep or factory.

## NODE COMPATIBILITY

Manufacturer	Model Number
 Igor® Enabling Smart Buildings™	NP50-60-C-F-5
 molex	180996-1001 180996-1002 180996-2001 180996-2002
 PLATFORMATICS	1 Channel Node, POE-LN2-1U-E 2 Channel Node, POE-LN2-2U-E 4 Channel Node, POE-LN2-4U-E

## DRIVE CURRENT SPECIFICS

	80C			90C			97C			90W	
	19A	25A	32A	15A	20A	27A	14A	19A	24A	11A	12A
Minimum Vf	30.5	30.5	30.5	30.5	30.5	30.5	30.5	30.5	30.5	30.5	30.5
Maximum Vf	39	39	39	39	39	39	39	39	39	39	39
Current mA	400	550	750	400	550	750	400	550	750	400	400
Wattage W	13.6	19.4	27.4	13.6	19.4	27.4	13.6	19.4	27.4	13.6	13.6

	10 DEGREE OPTIC		
	80C19A	90C15A	97C14A
Minimum Vf	30.5	30.5	30.5
Maximum Vf	39	39	39
Current mA	400	400	400
Wattage W	13.6	13.6	13.6

## WIRING DIAGRAM

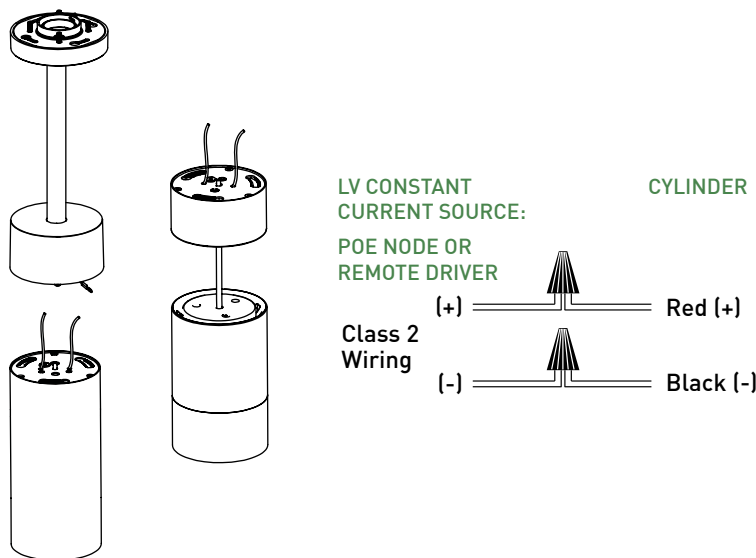

# CYLINDER 3 LVS FIXED SUSPENDED MOUNT

## ACCESSORIES

### FIXED BODY ALTERNATE BAFFLE AND EFFECTS DEVICE

Includes baffle with sealed lens. Must specify baffle finish.

**RBA-CY3-\*\*-HCL** Honeycomb Louver \*

\*(Not available for Warm Dim)

**RBA-CY3-\*\*-CGL** Clear Glass Lens \*

\*(Not available for Warm Dim)

**RBA-CY3-\*\*-SFL** Soft Focus Lens

**RBA-CY3-\*\*-FGL** Frosted Glass Lens

**RBA-CY3-\*\*-FSFL** Frosted Soft Focus Lens

**RBA-CY3-\*\*-FLSL** Frosted Linear Spread Lens

**RBA-CY3-\*\*-SFL-LSL** Soft Focus Lens W/ Linear Spread Film

**RBA-CY3-\*\*-CGL-LSL** Clear Glass Lens W/ Linear Spread Film

\*\* Baffle finish: Specify **WH** for white, **BK** for black, **AG** for satin silver or **AB** for architectural bronze.

### PENDANT ALTERNATE EFFECTS DEVICES

**HCL-CY3-03** Honeycomb Louver \*

\*(Not available for Warm Dim)

**CGL-CY3-03** Clear Glass Lens \*

\*(Not available for Warm Dim)

**SFL-CY3-03** Soft Focus Lens

**FGL-CY3-03** Frosted Glass Lens

**FSFL-CY3-03** Frosted Soft Focus Lens

**FLSL-CY3-03** Frosted Linear Spread Lens

**SFL-LSL-CY3-03** Soft Focus Lens W/ Linear Spread Film

**CGL-LSL-CY3-03** Clear Glass Lens W/ Linear Spread Film

### LOW FLUX AND WARM DIM REPLACEMENT OPTICS

Interchangeable optics accessible by removing snoot or baffle. Not available for Wallwash fixtures.

**RO-70-15-1** 15° optic \*

\*(Not available for Warm Dim)

**RO-70-25-1** 25° optic

**RO-70-40-1** 40° optic

**RO-70-60-1** 60° optic

### HIGH FLUX REPLACEMENT OPTICS

Interchangeable optics accessible by removing snoot or baffle. Not available for Wallwash fixtures.

**RO-70-15-2** 15° optic

**RO-70-25-2** 25° optic

**RO-70-40-2** 40° optic

**RO-70-60-2** 60° optic

### FIXED BODY REPLACEMENT SUCTION TOOL

Included with each CY2-FB order (1 per 10 fixtures).

**CY-SQ-TOOL-SUCTION** Baffle assembly removal tool

### Dropkit STEM EXTENSION

**RPS-DK-EXT-\*\*-\*\*** 2" - 43" Stem Extension

\*\* Stem finish: Specify **WH** for white, **BK** for black, **AG** for satin silver or **AB** for architectural bronze.

# CYLINDER 3 LVS FIXED SUSPENDED MOUNT

## WALLWASH DESIGN GUIDE



**8FT CEILING**  
**36" SETBACK / 48" ON CENTER SPACING**



**10FT CEILING**  
**36" SETBACK / 48" ON CENTER SPACING**



**12FT CEILING**  
**36" SETBACK / 48" ON CENTER SPACING**



**30" SETBACK / 42" ON CENTER SPACING**

- AVERAGE FC: 23.92
- MAX / MIN: 5.08
- 10FT CEILING SHOWN / 8-12FT IDEAL
- 7 FIXTURES / 25FT WALL SHOWN



### RECOMMENDED

**36" SETBACK / 48" ON CENTER SPACING**

- AVERAGE FC: 19.27
- MAX / MIN: 5.59
- 10FT CEILING SHOWN / 8-12FT IDEAL
- 7 FIXTURES / 28FT WALL SHOWN

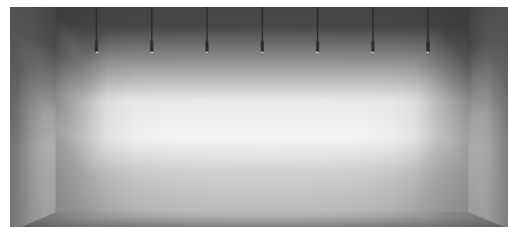

**42" SETBACK / 54" ON CENTER SPACING**

- AVERAGE FC: 15.63
- MAX / MIN: 6.19
- 10FT CEILING SHOWN / 8-12FT IDEAL
- 7 FIXTURES / 32FT WALL SHOWN

### ADDITIONAL SETBACKS AND SPACINGS

ON CENTER SPACING	SETBACK		
	30"	36"	42"
42"	SHOWN ABOVE	AVERAGE FC: 21.55 MAX / MIN: 5.77	AVERAGE FC: 19.33 MAX / MIN: 6.99
48"	AVERAGE FC: 21.35 MAX / MIN: 4.31	SHOWN ABOVE	AVERAGE FC: 17.30 MAX / MIN: 6.30
54"	AVERAGE FC: 19.31 MAX / MIN: 4.69	AVERAGE FC: 17.41 MAX / MIN: 5.43	SHOWN ABOVE

**\*ALL DATA REFLECTS 90C20A LUMEN PACKAGE**

# CYLINDER 3 LVS FIXED SUSPENDED MOUNT

## STATIC WHITE PERFORMANCE - 3000K

LUMEN PACKAGE	WATTAGE	10° OPTIC NO SOFT FOCUS LENS		15° OPTIC SOFT FOCUS LENS		25° OPTIC SOFT FOCUS LENS		40° OPTIC SOFT FOCUS LENS		60° OPTIC SOFT FOCUS LENS		WW OPTIC WALLWASH LENS	
		DELIVERED	LPW	DELIVERED	LPW	DELIVERED	LPW	DELIVERED	LPW	DELIVERED	LPW	DELIVERED	LPW
80C19A	17	1040	60	1352	80	1145	67	1127	66	1202	71	1280	75
80C25A	24	-	-	1802	76	1527	63	1502	63	1602	67	1699	71
80C32A	33	-	-	2353	71	1993	60	1961	59	2092	63	2218	67
90C15A	17	882	51	1158	68	987	58	905	53	1030	61	1096	64
90C20A	24	-	-	1544	65	1308	54	1287	54	1373	58	1456	61
90C27A	33	-	-	2016	61	1708	51	1680	51	1792	54	1834	56
97C14A	17	731	43	1037	61	878	51	863	51	921	54	980	58
97C19A	24	-	-	1382	58	1171	48	1151	48	1228	51	1317	55
97C24A	33	-	-	1804	55	1228	46	1503	46	1603	49	1706	52
90W11A	16	-	-	-	-	903	56	771	48	938	58	824	41
90W12A	16	-	-	-	-	1015	63	867	54	1054	65	926	57

OUTPUT MULTIPLIER	
CCT	CCT SCALE
2200K	0.800
2700K	0.957
3000K	1.000
3500K	1.019
4000K	1.030

LIGHT LOSS FACTOR MULTIPLIER	
No Lens	1.05
SFL	1.00
CGL	1.00
FGL	0.90
FSFL	0.87
FLSL	0.83
SFL W/ LINEAR SPREAD	0.82
CGL W/ LINEAR SPREAD	0.82
HCL	0.65

## WARM DIM PERFORMANCE - SOFT FOCUS LENS - 60° OPTIC

STANDARD WARM DIM PROFILE

90W12A 3000K - 1800K	Full on 100%	Dimmed to 80%	Dimmed to 70%	Dimmed to 50%	Dimmed to 20%	Dimmed to 10%	Dimmed to 2%
CCT (K)	3000	2950	2920	2775	2375	2000	1800
Light Output (Lm)	1054	843	737	527	210	105	21
Power (W)	14	11	10	7	3	1.5	0.3
Efficacy (LPW)	65	65	65	65	65	65	65

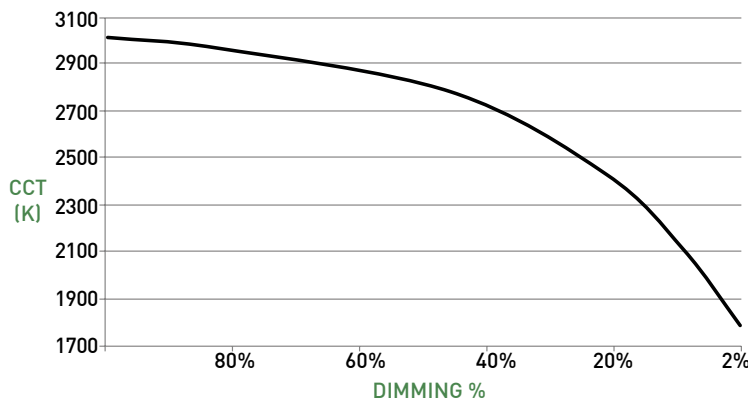

WARM DIM TO MIRROR INCANDESCENT DIMMING PROFILE

90W11A 2700K - 1800K	Full on 100%	Dimmed to 80%	Dimmed to 70%	Dimmed to 50%	Dimmed to 20%	Dimmed to 10%	Dimmed to 2%
CCT (K)	2700	2650	2620	2520	2180	1950	1800
Light Output (Lm)	938	750	656	469	187	93	18
Power (W)	16	13	11	8	3	1.7	0.3
Efficacy (LPW)	58	58	58	58	58	58	58

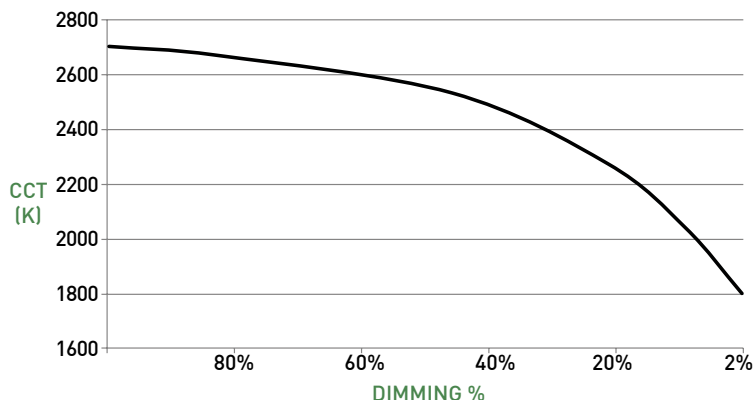

# CYLINDER 3 LVS FIXED SUSPENDED MOUNT

## Dropkit STEM ASSEMBLY

- A LUMINAIRE**  
Body with integrated heat sink and LED. Conceals mounting hardware. Power supply must be remote mount.
- B STANDARD OPTICS**  
Proprietary optics available in 10°, 15°, 25°, 40° & 60° beams.
- WALLWASH OPTIC**  
Precision tuned optic provides uniform wallwashing effect.
- C EFFECTS DEVICE**  
Cylinder baffle assembly can accept 1 lens. Soft focus lens, no lens or wallwash lens standard; lenses sealed in place.
- D BAFFLE**  
Baffle minimizes aperture glare and conceals view into fixture. Suction tool provided for removal of CY3-FB baffle.
- E Dropkit**
  - Field cuttable rigid stem for suspending fixture at desired height. Provides stable base to allow preferred fixture tilt, while maintaining vertical stem position.
  - Ball joint allows up to 45° tilt for sloped ceilings and can be locked once stem is positioned vertically.
  - Four 43" sections available; 172" maximum standard length.
  - Length adjustment occurs in lower canopy.
  - Wiring for kit provided by others.

## DIMENSIONS / DRAWINGS

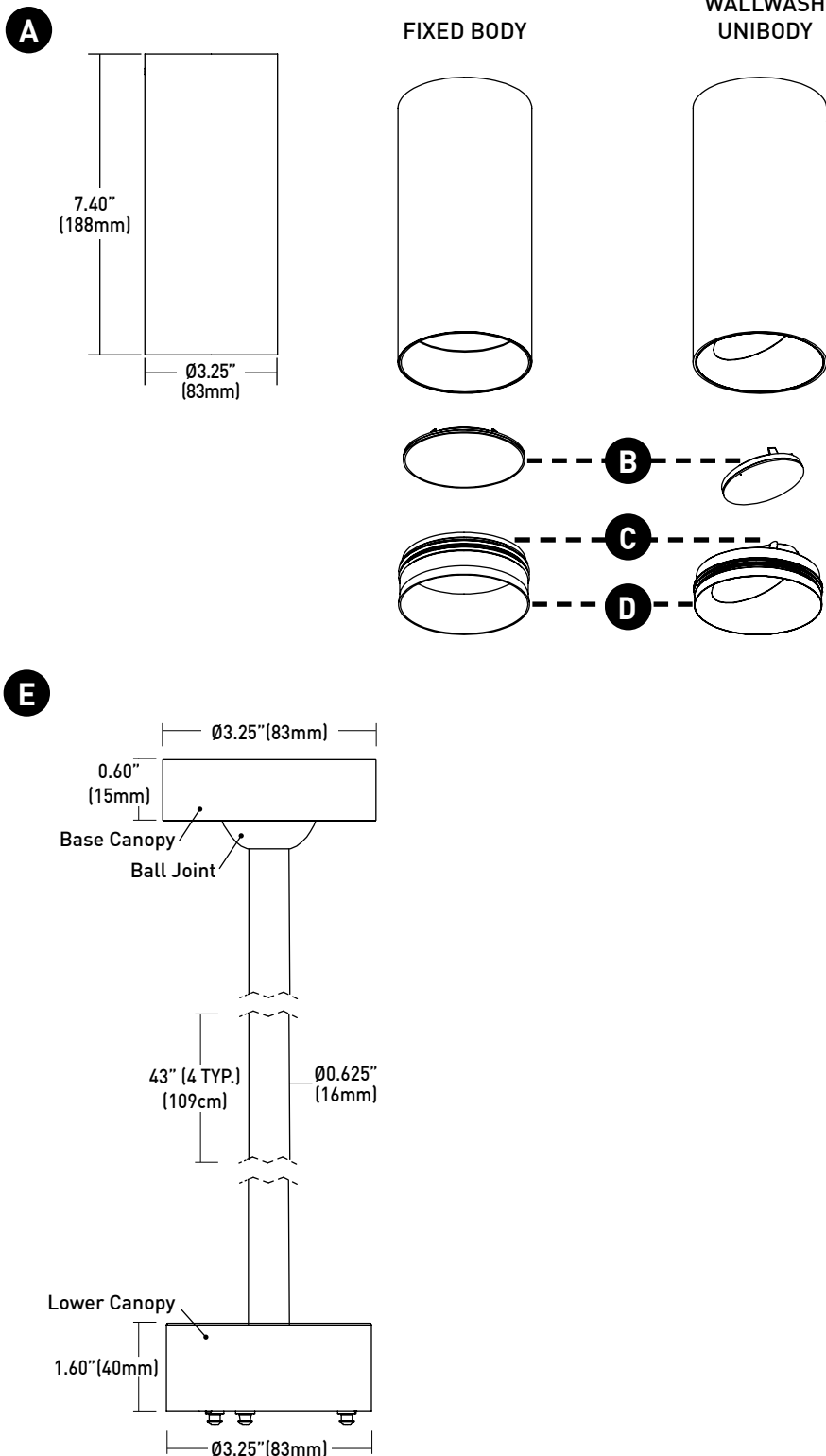

# CYLINDER 3 LVS FIXED SUSPENDED MOUNT

## PENDANT

## DIMENSIONS / DRAWINGS

- F CANOPY**  
Die-cast 1.60" (41mm) canopy accommodates flat and slope ceiling conditions. Conceals hidden twist-on mounting hardware. Power supply must be remote mount.
- G CABLE**  
Black and white wiring harness available; up to 180.0" length; cable may be cut in field.
- H LUMINAIRE**  
Die-cast body with integral heat sink and LED.
- I OPTICS**  
Proprietary optics available in 10°, 15°, 25°, 40° & 60° beams.
- J EFFECTS DEVICE**  
Cylinder baffle assembly can accept 1 lens; soft focus lens or no lens standard and sealed in place.
- K BAFFLE**  
Threaded removable cowling provides virtually seamless joint with fixture body.

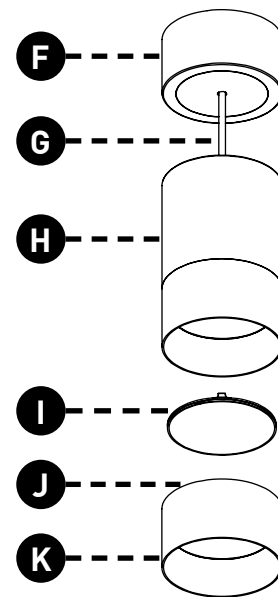
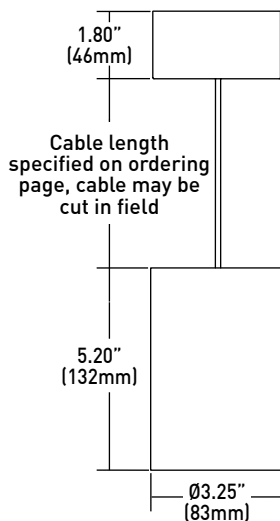

# CYLINDER 3 LVS FIXED SUSPENDED MOUNT

## Dropkit AND PENDANT MOUNTING

- L JBMP**  
Mounting plate (concealed) for standard 4" square or 4" 4/0 j-box . To be installed during rough-in prior to substrate. Fixture to mount flush with minimalist transition to ceiling.  
Part Number - CY2/3-JBMP or CD-JBMP
- M SMK3**  
Surface mount kit includes mounting plate and 4" concealer plate that installs between fixture and standard 3" 3/0 j-box for existing applications where standard j-box cutout is to be concealed.  
Part Number - CY2/3-SMK-3/0-(FINISH) or CD-SMK-3/0-(FINISH)
- N SMK4**  
Surface mount kit includes mounting plate and 5" concealer plate that installs between fixture and standard 4" 4/0 j-box for existing applications where standard j-box cutout is to be concealed.  
Part Number - CY2/3-SMK-4/0-(FINISH) or CD-SMK-4/0-(FINISH)
- O CMJB**  
Ceiling mount junction box perfectly matches the cylinder profile for a continuous, integrated look where exposed ceiling mount junction box and conduit applications apply. For use with 1/2" and 3/4" EMT conduit only. Features two conduit entrances on either side and one conduit knockout on top of j-box. J-box is IP10 rated; painted finishes only. Blank off plugs included.  
Part Number - CY2-CMJB-(FINISH) or CD-CMJB-(FINISH)

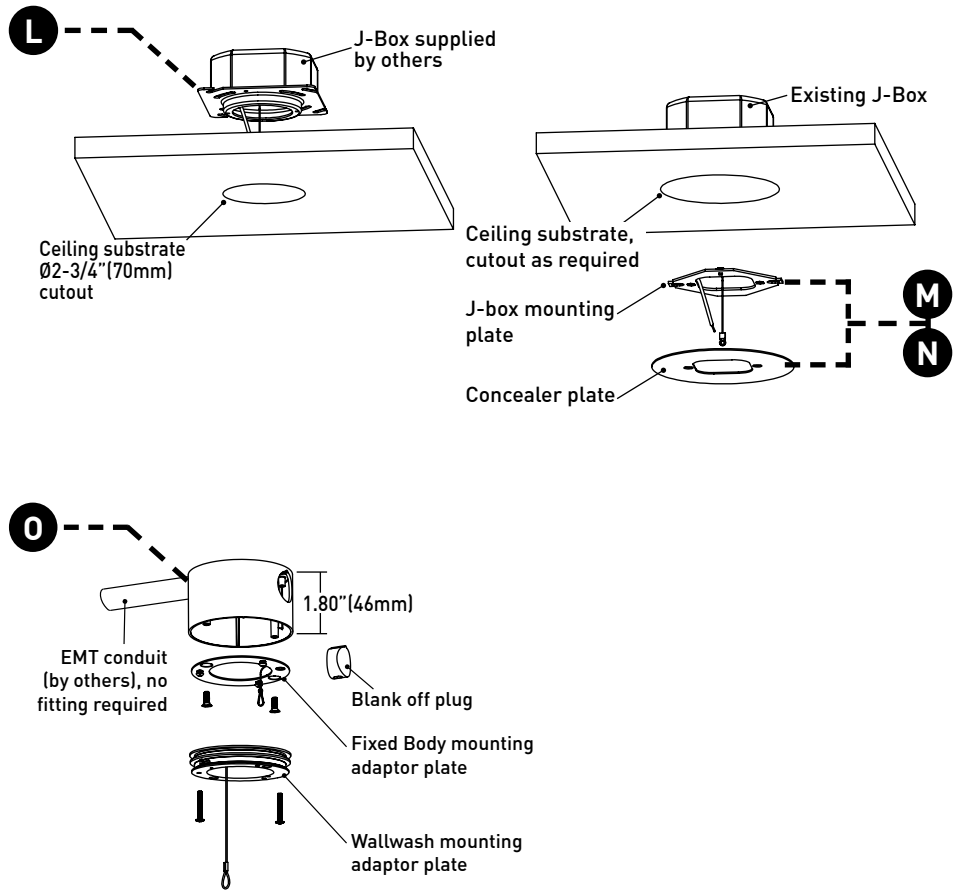

## MOUNTING NOTES

- CY2/3-JBMP and CY2/3-SMK-3/0 & 4/0 not recommended for use with pancake style j-box.
- Fixtures are surface mount and must have access to free air. For applications involving slat ceilings or confined mounting, consult Comprehensive Install Guide for required clearances for proper air flow and servicing.



# CYLINDER 3 LVS FIXED SUSPENDED MOUNT

## TECHNICAL

### CONSTRUCTION

**Cylinder:** Die-cast or Machined aluminum body; extruded aluminum internal heat-sink; painted finishes are granulated powder coat.

**Dropkit Stem Assembly:** Die-cast aluminum canopies and extruded aluminum stems; painted finishes are granulated powder coat.

**CMJB:** Die-cast aluminum body; painted finishes are granulated powder coat.

### STATIC WHITE LED

2-step MacAdam ellipse LED module available in 80+, 90+ and 97+ CRI configurations in color temperatures of 2200K, 2700K, 3000K, 3500K and 4000K. Average rated lamp life of 50,000 hours. LED and driver assemblies are field-replaceable.

### WARM DIM LED

3-step MacAdam ellipse warm dim LED module available in 90+ CRI configuration. 3000K or 2700K at full brightness, warming to 1800K at full dim. Average rated lamp life of 50,000 hours. LED and driver assemblies are field-replaceable.

### WALLWASH SPACING

Factory recommends 48" (1219mm) spacing on center with 36" (914mm) setback from wall plane.

### MOUNTING

Pendant is supplied with a mounting adaptor plate, which integrates with specified mounting component. Dropkit Stem integrates directly with specified mounting component. Both applications provide a minimalist transition from standard 4/0 or 4" square junction boxes and accommodating ceiling thicknesses of 0.44" (12mm) to 0.75" (19mm). Ceiling-mount junction box available for 1/2" (13mm) and 3/4" (19mm) conduit and feature concealed internal clamps for clean fitting-free conduit exit and entry.

### LISTING

cTUVus listed to UL2108 standard for Dry / Damp (IP10) locations.

### FIXTURE WEIGHT

CD3 / Mounting - 4.4 lbs

CP3 / Mounting - 3.2 lbs

### WARRANTY

Manufacturer's 1-year warranty guarantees product(s) listed to be free from defects in material and workmanship under normal use and service. 5-year warranty on LED to operate with 70% of the original flux and remain within a range of 3 duv. Warranty period begins from the date of shipment by Seller. [Consult website for full warranty terms and conditions.](#)

### CHANGE LOG

- 1.01/12/2021: ADDED 2200K, 2700K-1800K WARM DIM AND 10 DEGREE OPTIC OFFERINGS.
- 2.04/27/2021: ADDED LP1 DRIVER OFFERING.
- 3.11/17/2021: UPDATED 25° PHOTOMETRICS.
- 4.06/21/2022: ADDED SOFT FOCUS LENS W/ LINEAR SPREAD FILM, AND CLEAR GLASS LENS W/ LINEAR SPREAD FILM.
- 5.10/17/2022: REMOVED 90W13A 3200K-1800K WARM DIM AND ADDED 90W12A 3000K-1800K WARM DIM.