

CYLINDER 1 INTERNATIONAL SURFACE MOUNT

Our best-selling cylinders keep getting better. Adjustable, fixed, and wallwash are all offered in a broad range of sizes, with lumens from 500 to almost 5000lm, standard 90° tilt, and more than a dozen finish options. Now, there's a fixture for anywhere you need to illuminate anything.

PROJECT NAME:	TYPE:
---------------	-------



ORDERING INFORMATION

CYLINDER	FUNCTION	RATING	CYLINDER FINISH	BAFFLE FINISH	CRI / WATTAGE PACKAGE	CCT	OPTIC (UGR)	MEDIA	POWER SUPPLY	MOUNTING
CY1X										EXMP
CY1X 64mm Ø	AD 90° Adjustable AS 90° Adjustable Shallow Canopy* <small>*(Remote driver only)</small> AW Adjustable Wallwash FB Fixed WW Wallwash Fixed	1 Dry / Damp (IP30) 2 Wet (IP65)	POWDERCOAT FINISHES WH White AG Satin Silver AU Cashmere Gold AB Architectural Bronze BB Burnt Bronze BK Black CF Custom Finish* <small>*(Consult Factory)</small> ALUMINA FINISHES 01 Brushed Obsidian 02 Matte Obsidian 03 Brushed Dark Patinated Bronze 04 Matte Dark Patinated Bronze 05 Brushed Aged Aluminum 06 Matte Aged Aluminum 07 Brushed Cast Brass 08 Matte Cast Brass 09 Brushed Light Patinated Bronze 10 Matte Light Patinated Bronze FINISH IMAGES ON PAGE 2	POWDERCOAT FINISHES WH White AG Satin Silver AU Cashmere Gold AB Architectural Bronze BB Burnt Bronze BK Black CF Custom Finish* <small>*(Consult Factory)</small> ALUMINA FINISHES 01 Brushed Obsidian 02 Matte Obsidian 03 Brushed Dark Patinated Bronze 04 Matte Dark Patinated Bronze 05 Brushed Aged Aluminum 06 Matte Aged Aluminum 07 Brushed Cast Brass 08 Matte Cast Brass 09 Brushed Light Patinated Bronze 10 Matte Light Patinated Bronze FINISH IMAGES ON PAGE 2	STATIC WHITE 80S11A 80+ CRI, 11 Watts 1104 lm delivered 80S17A 80+ CRI, 17 Watts 1643 lm delivered 90S11A 90+ CRI, 11 Watts 952 lm delivered 90S17A 90+ CRI, 17 Watts 1416 lm delivered 97S11A 97+ CRI, 11 Watts 838 lm delivered 97S17A 97+ CRI, 17 Watts 1246 lm delivered WARM DIM 90W18A 90+ CRI, 18 Watts Incandescent Profile 1216 lm delivered Standard Profile 1202 lm delivered <small>*SEE PAGE 4 FOR DETAILED PERFORMANCE CONFIGURATIONS AND WARM DIM PROFILE COMPARISON.</small> TUNABLE WHITE (REMOTE DRIVER ONLY) 90T17A 90+ CRI, 17 Watts Warm Profile 1291 lm delivered Cool Profile 1251 lm delivered <small>*ALL DELIVERED LUMEN OUTPUTS AND T24 COMPLIANCE REFLECT 3000K PAIRED WITH 60° OPTIC AND SOFT FOCUS LENS.</small>	24 2400K* <small>*(90+CRI only)</small> 27 2700K 30 3000K 35 3500K 40 4000K WL 2700K - 1800K WD 3000K - 1800K TR 4000K - 1800K TH 5000K - 2700K	10 10° (<16) <small>*(17 Watts only)</small> 15 15° (<16) 20 20° (<10) 25 25° (<10) 40 40° (<10) 60 60° (<16) WW Wallwash* <small>*(Required for WW & AW fixture)</small> 20 20° (<10) 25 25° (<10) 40 40° (<10) 60 60° (<16) WW Wallwash* <small>*(Required for WW & AW fixture)</small>	STANDARD MEDIA 4 Soft Focus Lens (SFL) <small>*(Required for 10° optic)</small> ALTERNATE MEDIA 0 No Lens* <small>*(Not available for Warm Dim or Wet Location)</small> 2 Honey Comb Louver (HCL)* <small>*(Not available for Warm Dim or Wet Location)</small> 3 Clear Glass Lens (CGL)* <small>*(Not available for Warm Dim)</small> 5 Frosted Glass Lens (FGL) 6 Frosted Soft Focus Lens (FSFL) 7 Frosted Linear Spread Lens (FLSL) C Clear Glass Film w/ Honeycomb Louver S Soft Focus Film w/ Honeycomb Louver W Wallwash Lens* <small>*(Required for WW and AW fixture)</small>	INTEGRAL 2IE Electronic Forward / Reverse 220V-240V REMOTE (220-277V) 2EG eldoLED, SOLOdrive 0.1% 0-10V, LOG 2EN eldoLED, SOLOdrive 0.1% 0-10V, LIN 2ED eldoLED, SOLOdrive 0.1% DALI, LOG 2LD eldoLED, SOLOdrive 0.1% DALI, LIN TUNABLE WHITE REMOTE (220-277V) 2DD eldoLED, DUALdrive 0.1% DALI, LOG	EXMP Export Mounting Plate Features 76mm diameter canopy

PART NUMBER NOTES

- CY1X ships as e.g., CY1XAD1WHWH80S17A304042EA2
- Remote driver ships as e.g., PS-RMT-80S17A-2EG2

CYLINDER 1 INTERNATIONAL SURFACE MOUNT

ACCESSORIES

REPLACEMENT MEDIA

Dry / Damp location only, consult factory for wet location replacements

- SFL-CY1X-03** Soft Focus Lens
- HCL-CY1X-03** Honeycomb Louver *

*(Not available for Warm Dim)

- CGL-CY1X-03** Clear Glass Lens *

*(Not available for Warm Dim)

- FGL-CY1X-03** Frosted Glass Lens
- FSFL-CY1X-03** Frosted Soft Focus Lens
- FLSL-CY1X-03** Frosted Linear Spread Lens
- CGL-HCL-CY1X-03** Clear Glass Film W/ Honeycomb Louver
- SFL-HCL-CY1X-03** Soft Focus Film W/ Honeycomb Louver

STATIC WHITE REPLACEMENT OPTICS

- RO-50-15-S** 15° optic
- RO-50-20-S** 20° optic
- RO-50-25-S** 25° optic
- RO-50-40-S** 40° optic
- RO-50-60-S** 60° optic

WARM DIM REPLACEMENT OPTICS

- RO-50-20-W** 20° optic
- RO-50-25-W** 25° optic
- RO-50-40-W** 40° optic
- RO-50-60-W** 60° optic

TUNABLE WHITE REPLACEMENT OPTICS

- RO-50-15-T** 15° optic
- RO-50-20-T** 20° optic
- RO-50-25-T** 25° optic
- RO-50-40-T** 40° optic
- RO-50-60-T** 60° optic

SUCTION CUP TOOL

- CYX-TOOL-SUCTION** Baffle removal tool, provided with every 5 fixtures

EMERGENCY LIGHTING - REMOTE MOUNT ONLY

During disruption of main power, emergency battery inverter provides temporary 120V or 277V to fixture.

- EMB-S-25-120/277-LEDX** 25 watt max capacity, 120 or 277 VAC 60Hz
- EMB-S-100-120-LEDX** 100 watt max capacity, 120 VAC 60Hz, 0-10V dimmable
- EMB-S-100-277-LEDX** 100 watt max capacity, 277 VAC 60Hz, 0-10V dimmable
- EMB-S-250-120/277-LEDX** 250 watt max capacity, 120 or 277 VAC 60Hz

***SHUNT REQUIRED FOR USE WITH ATHENA AND CASAMBI CONTROLS, CONSULT FACTORY FOR DETAILS.**

POWDERCOAT FINISHES

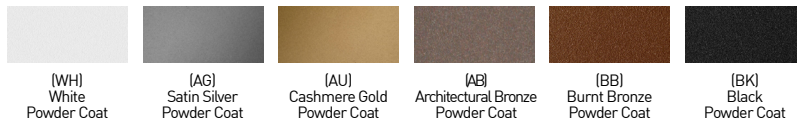

ALUMINA FINISHES BY LUCIFER LIGHTING™



CYLINDER 1 INTERNATIONAL SURFACE MOUNT

WALLWASH DESIGN GUIDE

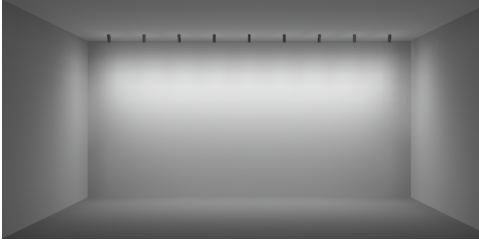

10° TILT

30" SETBACK / 30" ON CENTER SPACING

- 10FT CEILING SHOWN / 8-12FT IDEAL
- AVERAGE FC: 24.45
- MAX / MIN: 4.85
- 9 FIXTURES / 25FT WALL SHOWN



RECOMMENDED

15° TILT

36" SETBACK / 36" ON CENTER SPACING

- 10FT CEILING SHOWN / 8-12FT IDEAL
- AVERAGE FC: 21.75
- MAX / MIN: 4.35
- 9 FIXTURES / 30FT WALL SHOWN

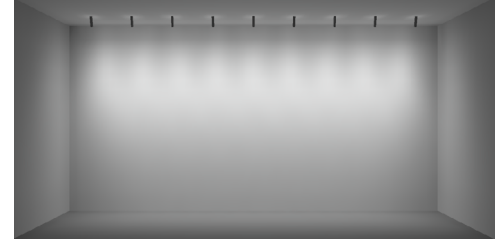

20° TILT

42" SETBACK / 42" ON CENTER SPACING

- 10FT CEILING SHOWN / 8-12FT IDEAL
- AVERAGE FC: 19.68
- MAX / MIN: 4.03
- 9 FIXTURES / 35FT WALL SHOWN

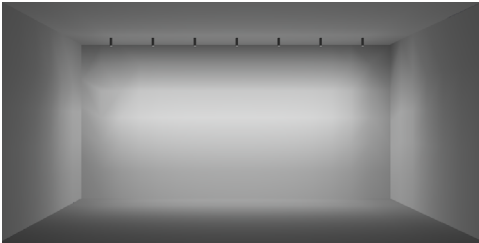

42" SETBACK / 30" ON CENTER SPACING

- 10FT CEILING SHOWN / 8-12FT IDEAL
- AVERAGE FC: 23.46
- MAX / MIN: 4.88
- 9 FIXTURES / 25FT WALL SHOWN

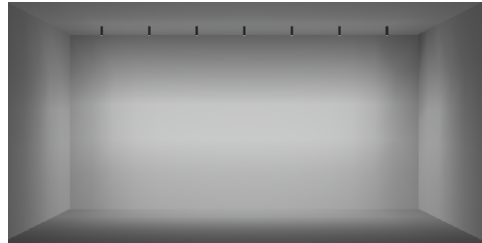

RECOMMENDED

48" SETBACK / 36" ON CENTER SPACING

- 10FT CEILING SHOWN / 8-12FT IDEAL
- AVERAGE FC: 18.62
- MAX / MIN: 4.76
- 9 FIXTURES / 30FT WALL SHOWN

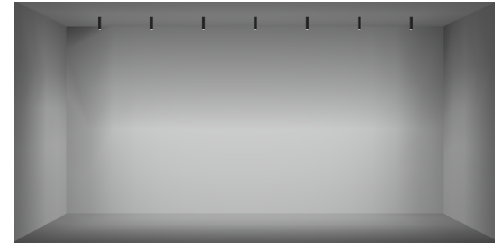

54" SETBACK / 42" ON CENTER SPACING

- 10FT CEILING SHOWN / 8-12FT IDEAL
- AVERAGE FC: 15.07
- MAX / MIN: 4.90
- 9 FIXTURES / 35FT WALL SHOWN

ADDITIONAL SETBACKS AND SPACINGS

ON CENTER SPACING	SETBACK / TILT			ON CENTER SPACING	SETBACK		
	30" / 10°	36" / 15°	42" / 20°		30"	36"	42"
30"	SHOWN ABOVE	AVERAGE FC: 25.42 MAX / MIN: 4.36	AVERAGE FC: 26.36 MAX / MIN: 4.14	42"	SHOWN ABOVE	AVERAGE FC: 20.84 MAX / MIN: 4.90	AVERAGE FC: 18.65 MAX / MIN: 5.04
36"	AVERAGE FC: 20.87 MAX / MIN: 4.97	SHOWN ABOVE	AVERAGE FC: 22.56 MAX / MIN: 4.08	48"	AVERAGE FC: 20.74 MAX / MIN: 4.66	SHOWN ABOVE	AVERAGE FC: 16.64 MAX / MIN: 5.04
42"	AVERAGE FC: 18.21 MAX / MIN: 5.17	AVERAGE FC: 18.94 MAX / MIN: 4.39	SHOWN ABOVE	54"	AVERAGE FC: 18.75 MAX / MIN: 4.75	AVERAGE FC: 16.82 MAX / MIN: 4.68	SHOWN ABOVE

***ALL DATA REFLECTS 90S17A WATTAGE PACKAGE**

CYLINDER 1 INTERNATIONAL SURFACE MOUNT

STATIC WHITE PERFORMANCE - 3000K

LUMEN PACKAGE	WATTS	10° OPTIC FIELD REDUCER		15° OPTIC SOFT FOCUS LENS		20° OPTIC SOFT FOCUS LENS		25° OPTIC SOFT FOCUS LENS		40° OPTIC SOFT FOCUS LENS		60° OPTIC SOFT FOCUS LENS		WALLWASH WALLWASH LENS		ADJ. WALLWASH WALLWASH LENS	
		DLVD	LPW	DLVD	LPW	DLVD	LPW	DLVD	LPW	DLVD	LPW	DLVD	LPW	DLVD	LPW	DLVD	LPW
80S11A	11	-	-	891	76	1080	98	1088	98	1002	91	1104	100	1160	105	908	82
80S17A/C	17	587	35	1451	73	1623	95	1624	95	1495	88	1643	96	1776	104	1357	79
90S11A	11	-	-	846	76	931	84	938	85	864	78	952	86	1000	90	783	71
90S17A/C	17	506	30	1251	73	1399	82	1400	82	1291	75	1416	83	1531	90	1170	68
97S11A	11	-	-	744	67	819	74	825	75	760	69	838	76	880	80	689	62
97S17A/C	17	437	26	1101	64	1231	72	1232	72	1136	66	1246	73	1347	79	1030	60
90W18AL (2700K-1800K)	18	-	-	-	-	1049	61	1023	60	930	54	997	58	1082	63	844	46
90W18AD (3000K-1800K)	18	-	-	-	-	1039	61	1014	59	934	54	979	57	1122	66	875	48
90T17ATR (4000K-1800K)	17	-	-	1112	65	1230	72	1234	72	1157	68	1291	75	1192	70	994	58
90T17ATH (5000K-2700K)	17	-	-	1100	64	1213	71	1215	71	1174	69	1251	73	1178	69	982	57

OUTPUT MULTIPLIER

CCT	CCT SCALE
2400K	0.76
2700K	0.957
3000K	1.000
3500K	1.019
4000K	1.030

MEDIA LIGHT LOSS FACTOR

MEDIA	LIGHT LOSS FACTOR
No Lens	1.07
CGL	0.99
SFL	1.00
FGL	0.90
FSFL	0.84
FLSL	0.85
HCL	0.68
SFL+HCL	0.63

Part L 75+ LPW configurations comply with residential Part L
95+ LPW configurations comply with commercial Part L

UNIFIED GLARE RATING

10° OPTIC FIELD REDUCER	15° OPTIC SOFT FOCUS LENS	20° OPTIC SOFT FOCUS LENS	25° OPTIC SOFT FOCUS LENS	40° OPTIC SOFT FOCUS LENS	60° OPTIC SOFT FOCUS LENS	WALLWASH WALLWASH LENS
<16	<16	<10	<10	<10	<16	>19

TUNABLE WHITE MULTIPLIER

CCT	5000K-2700K	4000K-1800K
5000K	1.16	-
4000K	1.08	1.14
3500K	1.04	1.07
3000K	1.00	1.00
2700K	0.96	0.92
2400K	-	0.84
1800K	-	0.69

WARM DIM PERFORMANCE - SOFT FOCUS LENS - 60° OPTIC

INCANDESCENT DIMMING PROFILE

90W18AL 2700K - 1800K	Full on 100%	Dimmed to 80%	Dimmed to 70%	Dimmed to 50%	Dimmed to 20%	Dimmed to 10%	Dimmed to 2%
CCT (K)	2700	2650	2620	2520	2180	1950	1800
Light Output (Lm)	1216	973	851	608	243	122	24
Power (W)	18	14	13	9	4	2	0.4
Efficacy (LPW)	67	67	67	67	67	67	67

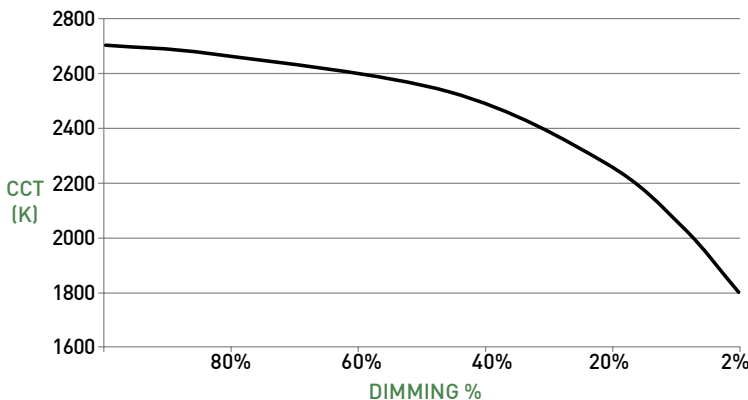

STANDARD DIMMING PROFILE

90W18AD 3000K - 1800K	Full on 100%	Dimmed to 80%	Dimmed to 70%	Dimmed to 50%	Dimmed to 20%	Dimmed to 10%	Dimmed to 2%
CCT (K)	3000	2950	2920	2775	2375	2000	1800
Light Output (Lm)	1202	962	841	601	240	120	24
Power (W)	18	14	13	9	4	2	0.4
Efficacy (LPW)	66	66	66	66	66	66	66

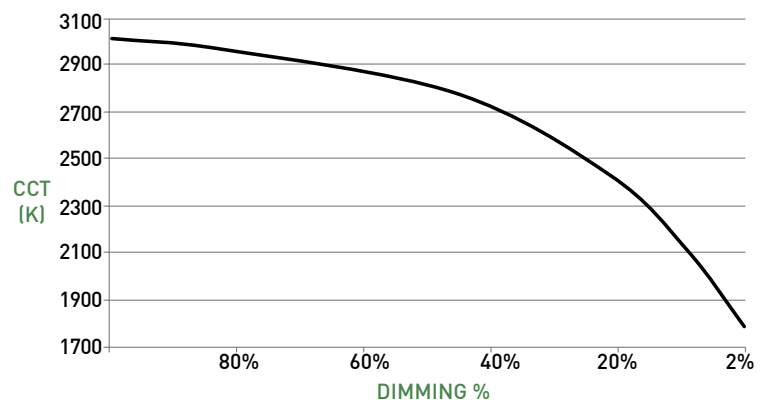

CYLINDER 1 INTERNATIONAL SURFACE MOUNT

CYLINDER ASSEMBLY

- A EXPORT MOUNTING PLATE**
Export mounting plate (concealed) to be installed above ceiling substrate. Features minimalist 76mm diameter canopy.
- B ADJUSTABLE - STANDARD CANOPY**
Die-cast canopy accommodates flat and sloped ceiling conditions. Conceals hidden mounting hardware. "AD" (90° tilt, 365° rotation) canopy features 1.76" [45mm] tall canopy. Available with integral or remote driver.
- C ADJUSTABLE - SHALLOW CANOPY**
Die-cast canopy accommodates flat and slope ceiling conditions. Conceals hidden mounting hardware. "AS" (90° tilt, 365° rotation) canopy features 0.65" (17mm) tall canopy, reducing overall height. Requires remote power supply.
- D FIXED BODY**
Body with integrated heat sink and LED. Conceals mounting hardware. Power supply may be integral or remote mount.
- E WALLWASH FIXED BODY**
- F1 OPTICS**
Robust light engine with optimized optic pairing integrates Reflection, Refraction, and TIR offering 10°, 15°, 20°, 25°, 40° & 60° beams.
- F2 10° FIELD REDUCER**
Included with 10° optic. Reduces field angle by 10%
- G MEDIA**
Cylinder accepts 2 lenses; soft focus lens, no lens, or wallwash lens standard. Sealed in place for Wet locations.
- H BAFFLE**
Die-cast baffle minimizes aperture glare and conceals view into fixture.
- I WALL-MOUNT**
Cylinder may be wall mounted using any mounting option.

REMOTE POWER SUPPLY

- J** Remote power supply provides additional driver options. See page 6 for maximum allowable wiring distance. Must be installed in an accessible location.

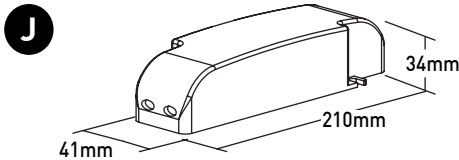

DIMENSIONS / DRAWINGS

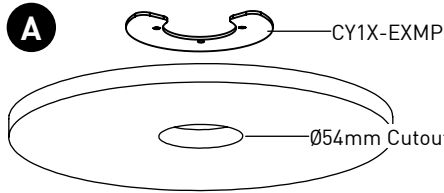

B ADJUSTABLE BODY STANDARD CANOPY

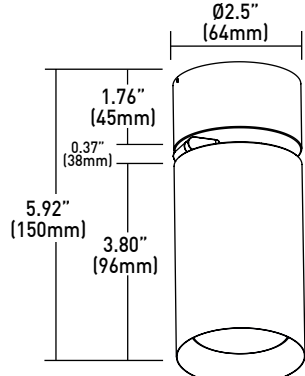

Cylinder weight
0.90 lbs

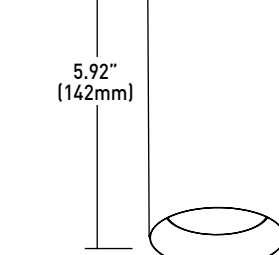
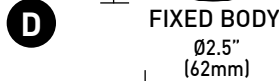
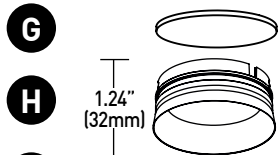
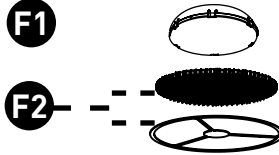

Cylinder weight
0.90 lbs



C ADJUSTABLE BODY SHALLOW CANOPY

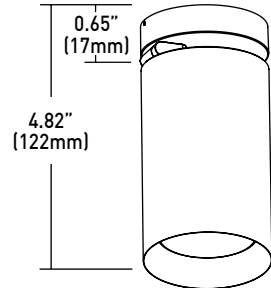

Cylinder weight
0.85 lbs

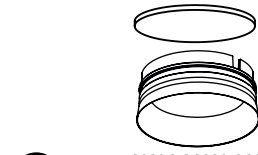

E WALLWASH FIXED BODY

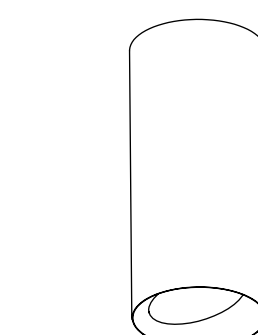

Cylinder weight
0.90 lbs

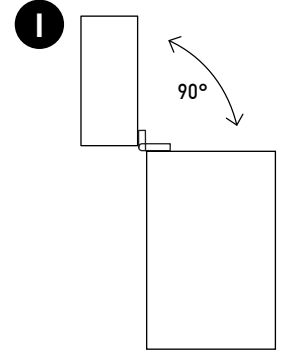
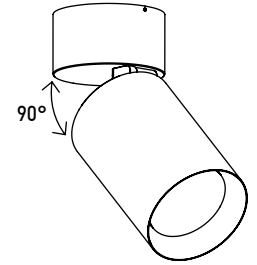

CYLINDER 1 INTERNATIONAL SURFACE MOUNT

TECHNICAL

CONSTRUCTION

Cylinder: Die-cast aluminum body with integrated heat sink; painted finishes are granulated powder coat. Alumina finishes are anodized aluminum.
Remote Power Supply: 22 Gauge galvanized steel.

STATIC WHITE LED

2-step MacAdam ellipse LED module available in 80+, 90+ and 95+ CRI configurations in color temperatures of 2700K, 3000K, 3500K and 4000K.

3-step MacAdam ellipse LED module available in 90+ CRI configuration in color temperature of 2400K. Average rated lamp life: 50,000 hours. LED and driver assemblies are field-replaceable.

WARM DIM LED

3-step MacAdam ellipse warm dim LED module available in 90+ CRI configuration. 3000K or 2700K at full brightness, warming to 1800K at full dim. Average rated lamp life of 50,000 hours. LED and driver assemblies are field-replaceable.

TUNABLE WHITE LED

3-Step MacAdam ellipse tunable white LED module available in 90+ CRI configuration. Features tuning range of 2700K to 5000K and 1800K to 4000K. Average rated lamp life of 50,000 hours. Driver assemblies are field-replaceable.

POWER SUPPLY PERFORMANCE AND DIMMING INFORMATION

Power Supply	PHASE			0-10V			DALI		
	2IE	2EG	2EN	2ED	2LD	2DD			
Minimum °C	-20 °C	-20 °C	-20 °C	-20 °C	-20 °C	-20 °C			
Maximum °C	40 °C	40 °C	40 °C	40 °C	40 °C	40 °C			
Dimming %	2.0%	0.1%	0.1%	0.1%	0.1%	0.1%			

Note: For EG and EN drivers consult chart on page 7 to confirm appropriate dimming curve for compatibility with selected control.

MAXIMUM ALLOWABLE REMOTE DRIVER WIRING DISTANCES

DRIVER	WIRE AWG				
	12	14	16	18	20
2EG, 2EN, 2ED, 2LD, 2DD	-	-	118'	72'	46'

WALLWASH SPACING AND TILT

Adjustable Wallwash Cylinder must be tilted to achieve wallwashing effect. Recommended adjustable spacing is 36" (914mm) on center with 36" (914mm) setback from wall plane with 15° tilt. Recommended fixed spacing is 36" (914mm) on center spacing with 48" (1219mm) setback from wall plane.

LISTING

Cylinders and drivers CE Listed for Dry / Damp and IP65 Wet locations. Integral drivers ENEC and CB Listed.

DECLARE

LBC Red List Approved.

PART L

Part L compliant for all 75+ LPW residential and 95+ LPW commercial configurations.

WARRANTY

Manufacturer's 1-year warranty guarantees product(s) listed to be free from defects in material and workmanship under normal use and service. 5-year warranty on LED and power supply to operate with 70% of the original flux and remain within a range of 3 duv. 10-year Lutron Advantage limited warranty available on Lutron equipped systems. Warranty period begins from the date of shipment by Seller. Consult [website](#) for full warranty terms and conditions.

CHANGE LOG

- 2/15/2024: PART L COMPLIANCE ADDED
- 3/15/2024: 10 DEGREE FIELD REDUCER ADDED, 10 DEGREE PERFORMANCE DATA UPDATED

CYLINDER 1 INTERNATIONAL SURFACE MOUNT

DIMMING COMPATIBILITY

eldoLED DRIVER COMPATIBILITY

Power supply EG Manufacturer	Family/Model #
Busch-Jaeger	2112U-101
Jung	240-10
Leviton Lighting Controls	IP710-DLX
Lightolier Controls	ZP600FAM120
Merten	5729
Pass & Seymour	CD4FB-W
The Watt Stopper	DCLV1
Synergy	ISD BC
Crestron®	GLX-DIMFLV8
Crestron®	GLXP-DIMFLV8
Crestron®	GLPAC-DIMFLV4-*
Crestron®	GLPAC-DIMFLV8-*
Crestron®	GLPP-DIMFLVEX-PM
Crestron®	GLPP-1DIMFLV2EX-PM
Crestron®	GLPP-1DIMFLV3EX-PM
Crestron®	DIN-A08
Crestron®	DIN-4DIMFLV4
Crestron®	CLS-EXP-DIMFLV
Crestron®	CLCI-1DIMFLV2EX
Power supply EN Manufacturer	Family/Model #
Lutron Electronics	Nova T® - NTFTV
Lutron Electronics	Diva® - DDTV
Lutron Electronics	Nova® - NFTV
Lutron Electronics	GrafixEye® GRX-TVI w GRX3503
Lutron Electronics	Energy Savr Node™ - QSN-4T16-S
Lutron Electronics	TVM2 Module
Sensor Switch	nIO EZ
ABB	SD/S 2.16.1

ANALOG DRIVERS AND DIMMERS

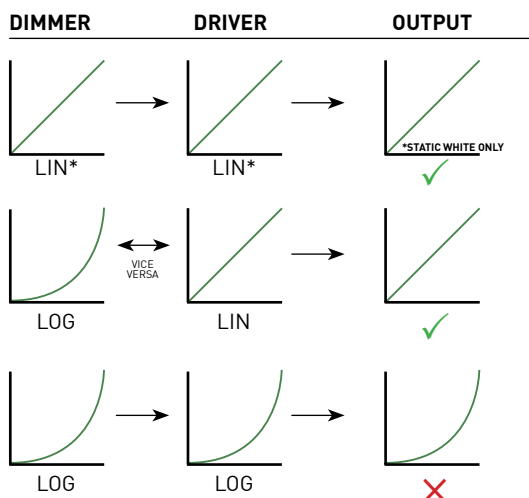

LIN = LINEAR

LOG = LOGARITHMIC

*LIN-TO-LIN NOT COMPATIBLE FOR WARM DIM