

SQUILINDER®

FIXED

SURFACE MOUNT

A modern update to a timeless form, this award-winning, fresh-faced classic offers sleek geometry, field-changeable optics, and endless adjustability.

PROJECT NAME:	TYPE:
---------------	-------

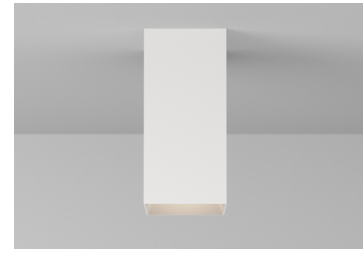

ORDERING INFORMATION - SQUILINDER



Quick Ship Product. All rough in components ship within 10 days up to quantities of 100.



JA8-2022 COMPLIANCE INDICATED BY SHADING

SQUILINDER	FIXTURE	RATING	SQUILINDER FINISH	BAFFLE FINISH	CRI / WATTAGE PACKAGE	OCT	OPTIC (UGR)	DRIVER	MEDIA	MOUNTING
SQ2		1								
SQ2 3.13"	FB Fixed Body WW Fixed Body Wallwash	1 Dry/Damp	WH White AG Satin Silver* *(Increased lead time) AB Architectural Bronze* *(Increased lead time) BK Black CF Custom Finish* *(Consult Factory)	WH White AG Satin Silver* *(Increased lead time) AB Architectural Bronze* *(Increased lead time) BK Black CF Custom Finish* *(Consult Factory)	STATIC WHITE 80S11A 80+ CRI, 11 Watts Lm. Delivered - 1278 80S17A 80+ CRI, 17 Watts Lm. Delivered - 1960 80S23A 80+ CRI, 23 Watts Lm. Delivered - 2541 90S11A 90+ CRI, 11 Watts Lm. Delivered - 1098 90S17A 90+ CRI, 17 Watts Lm. Delivered - 1684 90S23A 90+ CRI, 23 Watts Lm. Delivered - 2183 97S11A 97+ CRI, 11 Watts Lm. Delivered - 964 97S17A 97+ CRI, 17 Watts Lm. Delivered - 1479 97S23A 97+ CRI, 23 Watts Lm. Delivered - 1917 WARM DIM 90W18A 90+ CRI, 18 Watts Incandescent Profile Lm. Delivered - 1153 Halogen Profile Lm. Delivered - 1130 *SEE PAGE 4 FOR DETAILED WARM DIM PROFILE COMPARISON. TUNABLE WHITE 90T17A 90+ CRI, 17 Watts Warm Profile Lm. Delivered - 991 Cool Profile Lm. Delivered - 982 *ALL DELIVERED LUMEN OUTPUTS AND T24 COMPLIANCE REFLECT 3000K PAIRED WITH 20° OPTIC AND SOFT FOCUS LENS. REFERENCE PAGE 3 FOR ADDITIONAL T24 COMPLIANT CONFIGURATIONS.	24 2400K* *(90+ CRI only, 17W max) 27 2700K 30 3000K 35 3500K 40 4000K 20 20° (<10) 25 25° (<10) 40 40° (<13) 60 60° (<16) 15 15° (<16) 20 20° (<13) 25 25° (<16) 40 40° (<16) 60 60° (>19) TR 4000K - 1800K TH 5000K - 2700K WW Wallwash Optic*(>19) *(Required for Wallwash fixtures) *SEE PAGE 4 FOR UGR RATINGS	10 10** (>19) 15 15° (<16) 20 20° (<13) 25 25° (<16) 40 40° (<16) 60 60° (>19) WW Wallwash Optic*(>19) *(Required for Wallwash fixtures)	INTEGRAL CA3 120-277V 0-10V Analog CE3 120V Electronic Forward / Reverse REMOTE (120V) TR2 Philips, 2% Forward / Reverse L23 Lutron, Hi-Lume 1% 2-Wire REMOTE (120-277V) RA3 120-277V 0-10V Analog RE3 120V Electronic Forward / Reverse LH1 Lutron, Hi-Lume Ecosystem 1% Fade to Black LP1 Lutron, Hi-Lume Premier Ecosystem 0.1% Fade to Black AN4 Philips Xitanium 1% 0-10V, LOG LN2 Philips Xitanium 1% 0-10V, LIN EA2 eldoLED, SOLdrive 0.1% 0-10V, LOG LA2 eldoLED, SOLdrive 0.1% 0-10V, LIN ED1 eldoLED, SOLdrive 0.1% DALI-2, LOG LD1 eldoLED, SOLdrive 0.1% DALI-2, LIN AS1/ASR Athena Control eldoLED, SOLdrive 0.1% 120-277V* CS1/CSR Casambi Control eldoLED, SOLdrive 0.1% 120-277V* *(Includes Node, Extended lead time, consult factory. ASR/CSR includes shunt) TUNABLE WHITE REMOTE (0.1%, 120-277V) DD1 eldoLED, DUAl.drive DALI-2, LOG DG1 eldoLED, DUAl.drive 0-10V, LOG DN1 eldoLED, DUAl.drive 0-10V, LIN AD1/ADR Athena Control, eldoLED, DUAl.drive* CD1/CDR Casambi Control, eldoLED, DUAl.drive* *(Includes Node, Extended lead time, consult factory for EM use, ADR/CDR includes shunt)	STANDARD MEDIA 40 Soft Focus Lens* (Required for 10° optic) ALTERNATE MEDIA 00 No Lens* (Not available for Warm Dim) WW Wallwash Lens* *(Required for Wallwash fixtures) 20 Honeycomb Louver* *(Not available for Warm Dim) 30 Clear Glass Lens* *(Not available for Warm Dim) 50 Frosted Glass Lens 60 Frosted Soft Focus Lens 70 Frosted Linear Spread Lens 50 Soft Focus Lens w/ Linear Spread Film CO Clear Glass Lens w/ Linear Spread Film	ROUGH-IN JBMP 4" Sq. or 4/0 Junction Box Mounting Plate FINISH OUT SMK3 3/0 Surface Mount Kit SMK4 4/0 Surface Mount Kit CMJB 1/2" and 3/4" Conduit Ceiling Mount Junction Box* *(Quick Ship Product for WH and BK finishes only)

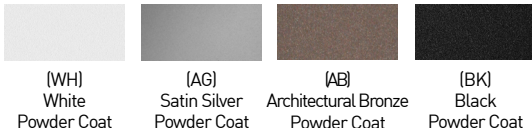

PART NUMBER NOTES

- Fixed Body ships as e.g., SQ2-FB1-WHBK-90S17A2-30CA340
- Wallwash ships as e.g., SQ2-WW1-WHBK-90S17A1-W0RMTW0
- Remote driver ships as e.g., PS-RMT-90S17A-1L23
- Mounting ships separate from fixture, part numbers listed on page 6.

SQUILINDER FIXED SURFACE MOUNT

ACCESSORIES

ALTERNATE BAFFLE AND MEDIA

Includes baffle with sealed lens. Must specify baffle finish.

RBA-SQ2--HCL-2** Honeycomb Louver *

*(Not available for Warm Dim)

RBA-SQ2--CGL-2** Clear Glass Lens *

*(Not available for Warm Dim)

RBA-SQ2--SFL-2** Soft Focus Lens

RBA-SQ2--FGL-2** Frosted Glass Lens

RBA-SQ2--FSFL-2** Frosted Soft Focus Lens

RBA-SQ2--FSL-2** Frosted Linear Spread Lens

RBA-SQ2--SFL-LSL-2** Soft Focus Lens W/ Linear Spread Film

RBA-SQ2--CGL-LSL-2** Clear Glass Lens W/ Linear Spread Film

** Baffle finish: Specify **WH** for white, **BK** for black, **AG** for satin silver or

AB for architectural bronze.

STATIC WHITE REPLACEMENT OPTICS

RO-70-15-S 15° optic

RO-70-20-S 20° optic

RO-70-25-S 25° optic

RO-70-40-S 40° optic

RO-70-60-S 60° optic

RO-70-WW-S Wallwash optic

WARM DIM REPLACEMENT OPTICS

RO-70-20-W 20° optic

RO-70-25-W 25° optic

RO-70-40-W 40° optic

RO-70-60-W 60° optic

RO-70-WW-W Wallwash optic

STATIC WHITE REPLACEMENT OPTICS

RO-70-15-T 15° optic

RO-70-20-T 20° optic

RO-70-25-T 25° optic

RO-70-40-T 40° optic

RO-70-60-T 60° optic

RO-70-WW-T Wallwash optic

REPLACEMENT SUCTION TOOL

Included with each order (1 per 10 fixtures).

CY-SQ-TOOL-SUCTION Baffle assembly removal tool

EMERGENCY LIGHTING - REMOTE MOUNT ONLY

EMB-S-25-120/277-LEDX 25 watt max capacity, 120 or 277 VAC 60Hz

EMB-S-100-120-LEDX 100 watt max capacity, 120 VAC 60Hz, 0-10V dimmable

EMB-S-100-277-LEDX 100 watt max capacity, 277 VAC 60Hz, 0-10V dimmable

EMB-S-250-120/277-LEDX 250 watt max capacity, 120 or 277 VAC 60Hz

During disruption of main power, emergency battery inverter provides temporary 120V or 277V to fixture.

SQUILINDER FIXED SURFACE MOUNT

WALLWASH DESIGN GUIDE

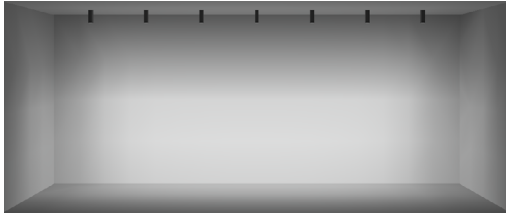

8FT CEILING
36" SETBACK / 48" ON CENTER SPACING

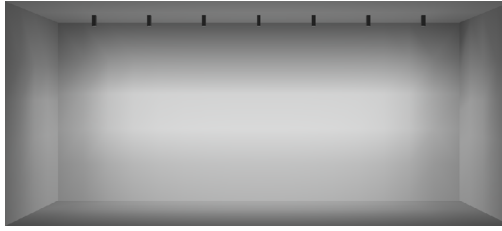

10FT CEILING
36" SETBACK / 48" ON CENTER SPACING

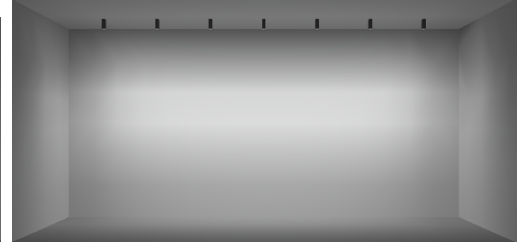

12FT CEILING
36" SETBACK / 48" ON CENTER SPACING

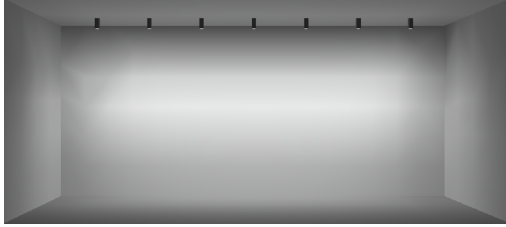

30" SETBACK / 42" ON CENTER SPACING

- AVERAGE FC: 17.19
- MAX / MIN: 5.71
- 10FT CEILING SHOWN / 8-12FT IDEAL
- 7 FIXTURES / 25FT WALL SHOWN

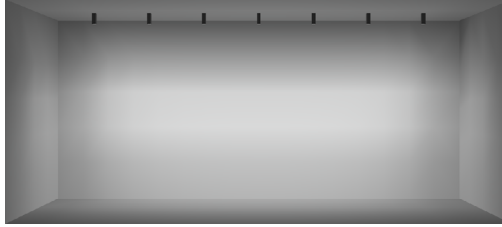

RECOMMENDED

36" SETBACK / 48" ON CENTER SPACING

- AVERAGE FC: 13.81
- MAX / MIN: 6.21
- 10FT CEILING SHOWN / 8-12FT IDEAL
- 7 FIXTURES / 28FT WALL SHOWN

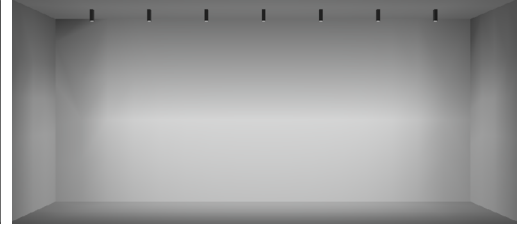

42" SETBACK / 54" ON CENTER SPACING

- AVERAGE FC: 11.14
- MAX / MIN: 7.32
- 10FT CEILING SHOWN / 8-12FT IDEAL
- 7 FIXTURES / 32FT WALL SHOWN

ADDITIONAL SETBACKS AND SPACINGS

ON CENTER SPACING	SETBACK		
	30"	36"	42"
42"	SHOWN ABOVE	AVERAGE FC: 15.45 MAX / MIN: 6.50	AVERAGE FC: 13.79 MAX / MIN: 7.36
48"	AVERAGE FC: 15.35 MAX / MIN: 5.35	SHOWN ABOVE	AVERAGE FC: 12.33 MAX / MIN: 7.20
54"	AVERAGE FC: 13.86 MAX / MIN: 5.40	AVERAGE FC: 12.47 MAX / MIN: 6.10	SHOWN ABOVE

***ALL DATA REFLECTS 90S17A WATTAGE PACKAGE**

SQUILINDER FIXED SURFACE MOUNT

STATIC WHITE PERFORMANCE - 3000K - SOFT FOCUS LENS

WATTAGE PACKAGE	WATTAGE	10° OPTIC SOFT FOCUS LENS		15° OPTIC SOFT FOCUS LENS		20° OPTIC SOFT FOCUS LENS		25° OPTIC SOFT FOCUS LENS		40° OPTIC SOFT FOCUS LENS		60° OPTIC SOFT FOCUS LENS		WW OPTIC WALLWASH LENS	
		DLVD	LPW	DLVD	LPW	DLVD	LPW	DLVD	LPW	DLVD	LPW	DLVD	LPW	DLVD	LPW
80S11A	11	-	-	1289	117	1278	116	1282	117	1222	111	1154	105	913	83
80S17A/C	17	716	42	1916	113	1960	115	1925	113	1846	109	1737	102	1395	82
80S23A	23	-	-	2440	106	2541	110	2515	109	2383	104	2240	97	1814	79
90S11A	11	-	-	1107	101	1098	100	1101	100	1050	95	991	90	784	71
90S17A/C	17	617	36	1646	97	1684	99	1654	97	1586	93	1492	88	1198	70
90S23A	23	-	-	2096	91	2183	95	2161	94	2047	89	1924	84	1558	68
97S11A	11	-	-	972	88	964	88	967	88	922	84	870	79	688	63
97S17A/C	17	532	31	1445	85	1479	87	1452	85	1392	82	1310	77	1052	62
97S23A	23	-	-	1840	80	1917	83	1897	82	1797	78	1689	73	1368	59
90W18AL (2700K-1800K)	18	-	-	-	-	1153	64	1133	63	1095	61	1037	58	858	48
90W18AD (3000K-1800K)	18	-	-	-	-	1130	63	1132	63	1093	61	1047	58	881	49
90T17ATR (4000K-1800K)	17	-	-	985	58	991	59	999	59	938	56	904	54	923	55
90T17ATH (5000K-2700K)	17	-	-	977	58	982	58	990	59	930	55	896	53	905	54

MEDIA LIGHT LOSS MULTIPLIER

MEDIA	LIGHT LOSS FACTOR
No Lens	1.06
SFL	1.00
CGL	0.98
FGL	0.91
FSFL	0.87
FLSL	0.82
SFL W/ LIN. SPREAD	0.76
CGL W/ LIN. SPREAD	0.74
HCL	0.73

OUTPUT MULTIPLIER

CCT	CCT SCALE
2400K	0.76
2700K	0.97
3000K	1.00
3500K	1.03
4000K	1.08

TUNABLE WHITE MULTIPLIER

CCT	5000K-2700K	4000K-1800K
5000K	1.16	-
4000K	1.08	1.14
3500K	1.04	1.07
3000K	1.00	1.00
2700K	0.96	0.92
2400K	-	0.84
1800K	-	0.69



JA8-2022 INDICATED BY SHADING

UNIFIED GLARE RATING

10° OPTIC SOFT FOCUS LENS	15° OPTIC SOFT FOCUS LENS	20° OPTIC SOFT FOCUS LENS	25° OPTIC SOFT FOCUS LENS	40° OPTIC SOFT FOCUS LENS	60° OPTIC SOFT FOCUS LENS
>19	<16	<13	<16	<16	<19

WARM DIM PERFORMANCE - SOFT FOCUS LENS - 20° OPTIC

INCANDESCENT PROFILE

90W18AL 2700K - 1800K	Full on 100%	Dimmed to 80%	Dimmed to 70%	Dimmed to 50%	Dimmed to 20%	Dimmed to 10%	Dimmed to 2%
CCT (K)	2700	2650	2620	2520	2180	1950	1800
Light Output (Lm)	1153	922	807	576	231	115	23
Power (W)	18	14	13	9	4	2	.4
Efficacy (LPW)	64	64	64	64	64	64	64

HALOGEN PROFILE

90W18AD 3000K - 1800K	Full on 100%	Dimmed to 80%	Dimmed to 70%	Dimmed to 50%	Dimmed to 20%	Dimmed to 10%	Dimmed to 2%
CCT (K)	3000	2950	2920	2775	2375	2000	1800
Light Output (Lm)	1130	904	791	565	226	113	23
Power (W)	18	14	13	9	4	2	.4
Efficacy (LPW)	62	62	62	62	62	62	62

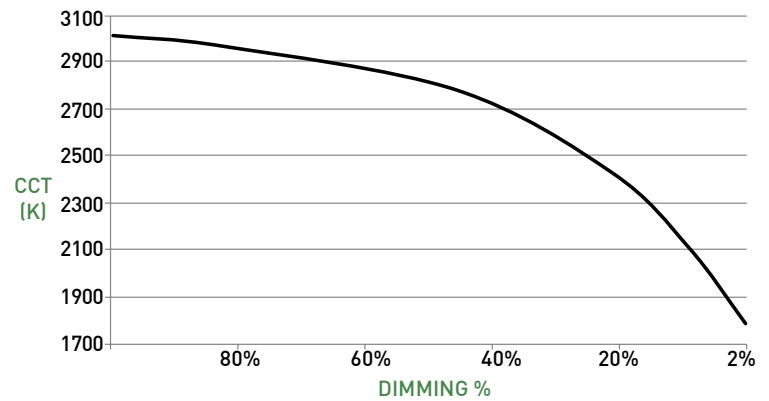
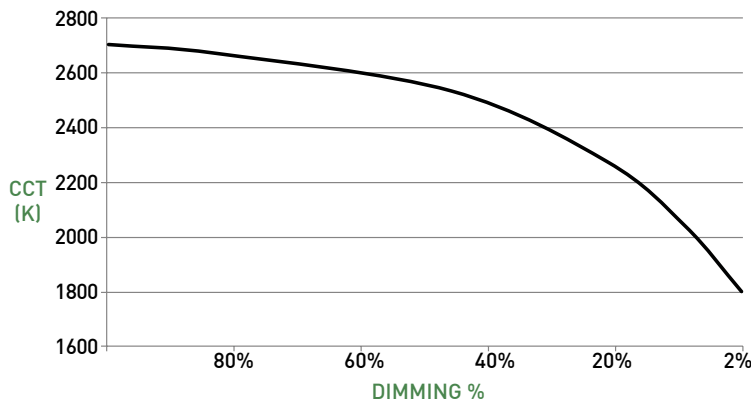

SQUILINDER FIXED SURFACE MOUNT

FIXTURE

- A LUMINAIRE**
Machined body with integral heat sink and LED. Power supply may be integral or remote mount.
- B1 FIXED BODY OPTIC**
Robust light engine with optimized optic pairing integrates Reflection, Refraction, and TIR offering 10°, 15°, 20°, 25°, 40° & 60° beams.
- WALLWASH OPTIC**
Precision tuned optic provides uniform wallwashing effect.
- B2 10° FIELD REDUCER**
Included with 10° optic. Reduces field angle by 6%
- C FIXED BODY MEDIA**
Soft focus lens standard; lenses sealed in place. Fixture can accept 1 media.
- WALLWASH MEDIA**
Wallwash lens is sealed in place. Fixture can accept 1 media.
- D BAFFLE**
Baffle minimizes aperture glare and conceals view into fixture. Suction tool provided for removal of baffle.

DIMENSIONS / DRAWINGS

A

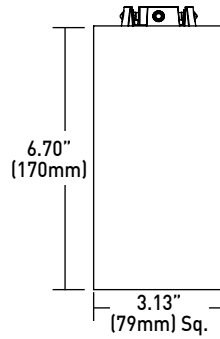

FIXED BODY

FIXED BODY
WALLWASH

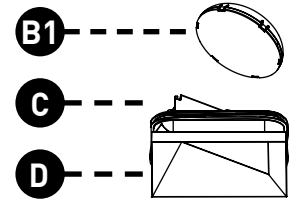
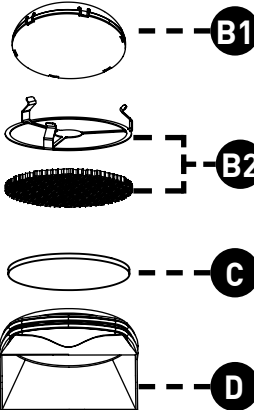
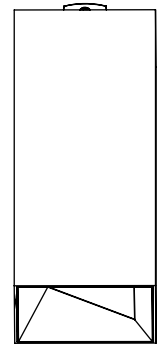

SQUILINDER FIXED SURFACE MOUNT

MOUNTING

- E JBMP**
Mounting plate (concealed) for standard 4" square or 4" 4/0 j-box. To be installed during rough-in prior to substrate. Fixture to mount flush with minimalist transition to ceiling.
Part Number - SQ2-JBMP
- F SMK3**
Surface mount kit includes mounting plate and 4" concealer plate that installs between fixture and standard 3" 3/0 j-box for existing applications where standard j-box cutout is to be concealed.
Part Number - SQ2-SMK-3/0-(FINISH)
- G SMK4**
Surface mount kit includes mounting plate and 5" concealer plate that installs between fixture and standard 4" 4/0 j-box for existing applications where standard j-box cutout is to be concealed.
Part Number - SQ2-SMK-4/0-(FINISH)
- H CMJB**
Ceiling mount junction box perfectly matches the squilinder profile for a continuous, integrated look where exposed ceiling mount junction box and conduit applications apply. For use with 1/2" and 3/4" EMT conduit only. Features three conduit entrances at 12, 3, and 6 o'clock plus one conduit knockout on top. Painted finishes only. Blank off plugs included.
Part Number - SQ2-CMJB-(FINISH)

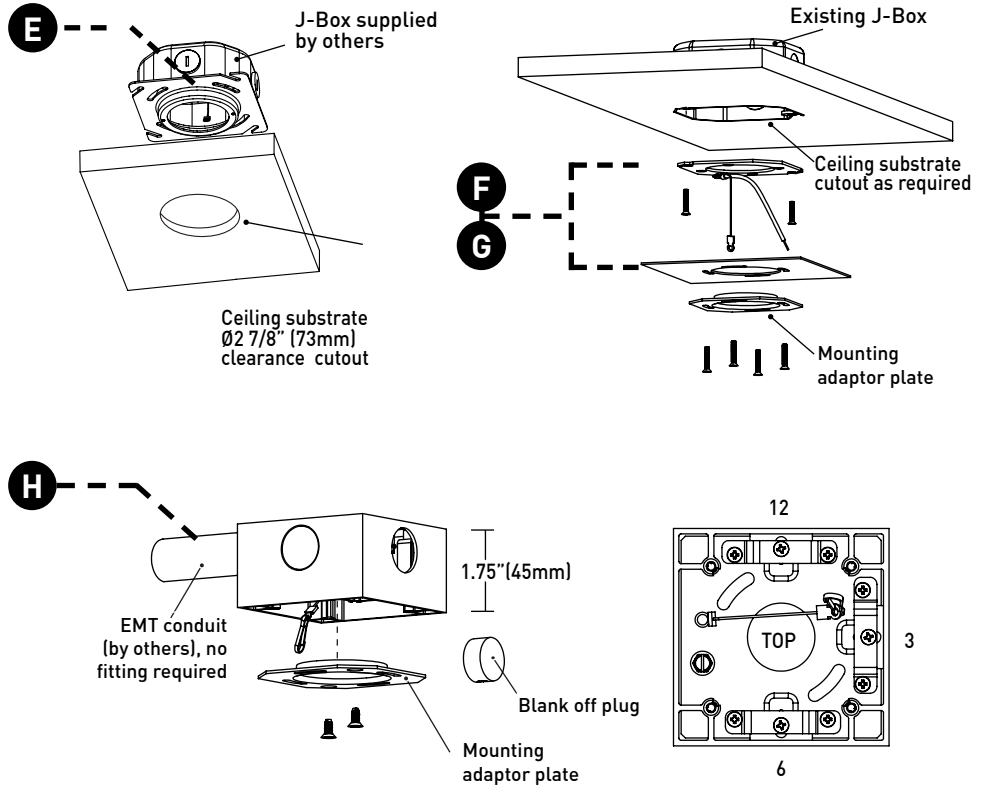

MOUNTING NOTES

- JBMP not recommended for use with pancake style j-box.
- For applications involving slat ceilings or confined mounting, consult Comprehensive Install Guide for required clearances for proper air flow and servicing.

REMOTE POWER SUPPLY

- I PS-RMT**
Remote power supply provides additional driver options. Mounting device still required. Consult install guide for maximum allowable secondary run lengths between PS-RMT and fixture.
- J ATHENA / CASAMBI CONTROL**
Controls integrated into housing or remote driver assembly. All equipment is serviceable.
Athena Model Numbers: A-WN-D01-RF-BL & DFC-OEM-DBI
Casambi Model Number: BT-S1E1-5400
- K ATHENA / CASAMBI EM SHUNT**
Included with drivers specified as ASR, ADR, CSR, or CDR. One required for each wireless EM fixture, requires class 2 control wiring between fixture and shunt. Features integrated test switch.
Model Number: PS-RMT-SHUNT

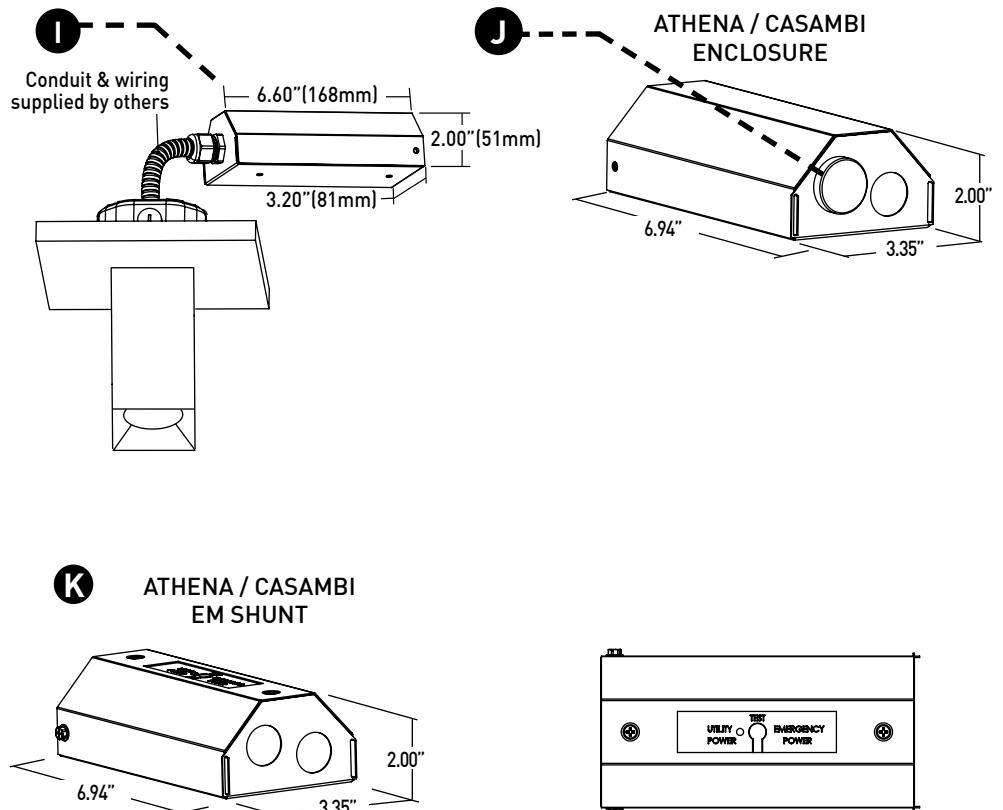

SQUILINDER FIXED SURFACE MOUNT

TECHNICAL

CONSTRUCTION

Squilinder: Machined aluminum body; painted finishes are granulated powder coat.
CMJB: Die-cast aluminum body; painted finishes are granulated powder coat.
Remote Power Supply: 22 Gauge galvanized steel.

STATIC WHITE LED

2-step MacAdam ellipse LED module available in 80+, 90+ and 97+ CRI configurations in color temperatures of 2700K, 3000K, 3500K and 4000K.
 3-step MacAdam ellipse LED module available in 90+ CRI configuration in color temperature of 2400K. Average rated lamp life of 50,000 hours. LED and driver assemblies are field-replaceable.

WARM DIM LED

3-step MacAdam ellipse warm dim LED module available in 90+ CRI configuration. 3000K or 2700K at full brightness, warming to 1800K at full dim. Average rated lamp life of 50,000 hours. LED and driver assemblies are field-replaceable.

TUNABLE WHITE LED

3-step MacAdam ellipse tunable white LED module available in 90+ CRI configuration. Features tuning range of 2700K to 5000K and 1800K to 4000K. Average rated lamp life of 50,000 hours. Driver assemblies are field-replaceable.

POWER SUPPLY PERFORMANCE AND DIMMING INFORMATION

Power Supply	PHASE			0-10V								ECO		DALI			ATHENA	CASAMBI
	CE3/RE3	TR2	L23	CA3/RA3	AN4	EA2	LN2	EA2	LA2	DG1	DN1	LP1	LH1	ED1	LD1	DD1	AS1/AD1	CS1/CD1
Minimum °C	-20 °C	-20 °C	0 °C	-20 °C	-20 °C	-20 °C	-20 °C	-20 °C	-20 °C	-20 °C	-20 °C	0 °C	0 °C	-20 °C	-20 °C	-20 °C	0 °C	-20 °C
Maximum °C	40 °C	40 °C	40 °C	40 °C	40 °C	40 °C	40 °C	40 °C	40 °C	40 °C	40 °C	40 °C	40 °C	40 °C	40 °C	40 °C	40 °C	40 °C
Dimming %	2.0%	2.0%	1.0%	2.0%	1.0%	0.1%	1.0%	0.1%	0.1%	0.1%	0.1%	0.1%	1.0%	0.1%	0.1%	0.1%	0.1%	0.1%

Note: For TR2, L23, LH1, LP1, AN4, LN2, EA2 and LA2 drivers consult chart on page 8 to confirm appropriate dimming curve for compatibility with selected control.

MAXIMUM ALLOWABLE REMOTE DRIVER WIRING DISTANCES

DRIVER	WIRE AWG				
	12	14	16	18	20
RA, RE	-	164'	105'	66'	40'
TR2, AN4, LN2	285'	180'	113'	71'	45'
L23, LH1, LP1	60'	40'	25'	15'	-
EA2, LA2, ED1, LD1, DG1, DD1, DN1 AS1, CS1, AD1, CD1	-	-	118'	72'	46'

WALLWASH SPACING

Factory recommends 48" (1219mm) spacing on center with 36" (914mm) setback from wall plane.

MOUNTING

Squilinder is supplied with a mounting adaptor plate, which integrates with JBMP, providing a minimalist transition from standard 4/0 or 4" square junction boxes and accommodating ceiling thicknesses of 0.44" (12mm) to 0.75" (19mm). Ceiling-mount junction box available for 1/2" (13mm) and 3/4" (19mm) conduit and feature concealed internal clamps for clean fitting-free conduit exit and entry.

LISTING

cTUVus listed to UL1598 standard for Dry / Damp (IP14) locations. Title 24 JA8-2022 Listed. NEMA 410 compliant.

WEIGHT

Fixture and Mounting - 3.8 lbs
 Remote Driver - 1.4 lbs

LIMITED WARRANTY

Manufacturer's 1-year warranty guarantees product(s) listed to be free from defects in material and workmanship under normal use and service. 5-year warranty on LED and power supply to operate with 70% of the original flux and remain within a range of 3 duv. 10-year Lutron Advantage limited warranty available on Lutron equipped systems. Warranty period begins from the date of shipment by Seller. Consult [website](#) for full warranty terms and conditions.

CHANGE LOG

- 01/12/2021: ADDED 2200K, 2700K-1800K WARM DIM AND 10 DEGREE OPTIC OFFERINGS.
- 03/17/2021: ADDED SMK MOUNTING OPTION.
- 04/29/2021: ADDED FIXED BODY WALLWASH AND LP1 DRIVER OFFERINGS.
- 06/09/2022: ADDED HONEYCOMB LOUVER, SOFT FOCUS LENS W/ LINEAR SPREAD FILM, AND CLEAR GLASS LENS W/ LINEAR SPREAD FILM.
- 10/17/2022: REMOVED 90W13A 3200K-1800K WARM DIM AND ADDED 90W12A 3000K-1800K WARM DIM.
- 08/08/2023: ADDED NEW LED AND OPTIC OFFERINGS. REMOVED 2200K OFFERING.
- 1/11/2024: ADDED ATHENA/CASAMBI OFFERINGS, ADDED 2400K OFFERING.
- 2/7/2024: ADDED TUNABLE WHITE OFFERING.
- 3/15/24: ADDED 10 DEGREE FIELD REDUCER, UPDATED 10 DEGREE PERFORMANCE DATA.

SQUILINDER FIXED SURFACE MOUNT

DIMMING COMPATIBILITY

PHILIPS DRIVER COMPATIBILITY

Power supply TR2 Manufacturer	Family/Model #
Lutron Electronics	DV-600P
Lutron Electronics	DVELV-303P
Lutron Electronics	NTELV-600
Lutron Electronics	MAELV-600
Lutron Electronics	SELV-300P
Lutron Electronics	DVLV-600P
Lutron Electronics	NFTU-5A
Lutron Electronics	CTCL-153P
Lutron Electronics	GL-600H
Lutron Electronics	S-600P
Lutron Electronics	PHPM
Power supply AN4 / LN2 Manufacturer	Family/Model #
Lutron Electronics	DVTV plus PP-DV
Lutron Electronics	DVSCTV plus PP-DV
Lutron Electronics	DVSTV
Lutron Electronics	DVSCSTV
Lutron Electronics	QSGRJ-XP plus GRX-TVI
Lutron Electronics	QSGRJ-XE plus GRX-TVI
Lutron Electronics	QSGR-XE plus GRX-TVI
Lutron Electronics	NFTV plus PP-DV
Lutron Electronics	NTSTV
Lutron Electronics	RMJ-5T
Lutron Electronics	RMJS-8T
Lutron Electronics	FCJS-010
Leviton	IllumaTch IP7 series
Philips	Sunrise - SR1200ZTUNV

LUTRON DRIVER COMPATIBILITY

Power supply L23 Lutron Product Family	Part No.
Maestro WirelessR 600 W dimmer	MRF2-6ND-120-
Maestro WirelessR 1000 W dimmer	MRF2-10ND-120-
Caséta® Wireless Pro 1000 W dimmer	PD-10NXD-
GRAFIK T™ CL® dimmer	GT-250M-GTJ-250M-
HomeWorks® QS adaptive dimmer	HQRD-6NA-
HomeWorks® QS 600 W dimmer	HQRD-6ND-
HomeWorks® QS 1000 W dimmer	HQRD-10ND-
RadioRA® 2 adaptive dimmer	RRD-6NA-
RadioRA® 2 1000 W dimmer	RRD-10ND
myRoom™ DIN power module	MQSE-4A1-D
HomeWorks® QS DIN power module	LQSE-4A1-D
HomeWorks® QS wallbox power module	HQRJ-WPM-6D-120
HomeWorks® wallbox power module	HWI-WPM-6D-120
GRAFIK Eye® QS control unit	QSGR-, QSGRJ-
GRAFIK Eye® 3000 control unit	GRX-3100-GRX-3500-
RPM-4U module (LCP, HomeWorks® QS, GRAFIK Systems™, Quantum®)	HW-RPM-4U-120 LP-RPM-4U-120
RPM-4A module (LCP, HomeWorks® QS, GRAFIK Systems™, Quantum®)	HW-RPM-4A-120, LP-RPM-4A-120
GP dimming panels	Various
Ariadni CL 250W dimmer	AYCL-253P-
Diva CL 250W dimmer	DVCL-253P-DCSCCL-253P-
Nova T CL 250W dimmer	NTCL-250-
Power supply LH1 / LP1 Lutron Product Family	Part No.
PowPak Dimming Modules	RMJ-ECO32-DV-B
PowPak Dimming Modules	FCJ/FCJS-ECO
Energi Savr Nodes	QSN-1ECO-S
GRAFIK Eye QS control unit	QSN-2ECO-S
Homeworks QS control unit	QSGRJ- _E (wireless) QSGR- _E
Quantum Hub	QP2-__ 2C
Quantum Hub	QP2-__ 4C
Quantum Hub	QP2-__ 6C
Quantum Hub	QP2-__ 8C
Homeworks QS power module	LQSE-2ECO-D
myRoom Plus power module	

eldoLED DRIVER COMPATIBILITY

Power supply EA2 / LA2 Dimmer / Switch Control Manufacturer	Family/Model #
Busch-Jaeger	2112U-101
Jung	240-10
Leviton Lighting Controls	IP710-DLX
Lightolier Controls	ZP600FAM120
Lutron Electronics	Nova T® - NTFTV
Lutron Electronics	Div@ - DDTV
Lutron Electronics	Nova® - NFTV
Merten	5729
Pass & Seymour	CD4FB-W
The Watt Stopper	DCLV1
Sensor Switch	nIO EZ
Synergy	ISD BC
Power supply EA2 / LA2 Lighting Control Systems Manufacturer	Family/Model #
Lutron Electronics	GrafixEye® GRX-TVI w GRX3503
Lutron Electronics	Energy Savr Node™ - QSN-4T16-S
Lutron Electronics	TVM2 Module
Crestron®	GLX-DIMFLV8
Crestron®	GLXP-DIMFLV8
Crestron®	GLPAC-DIMFLV4-*
Crestron®	GLPAC-DIMFLV8-*
Crestron®	GLPP-DIMFLVEX-PM
Crestron®	GLPP-1DIMFLV2EX-PM
Crestron®	GLPP-1DIMFLV3EX-PM
Crestron®	DIN-A08
Crestron®	DIN-4DIMFLV4
Crestron®	CLS-EXP-DIMFLV
Crestron®	CLCI-1DIMFLV2EX
ABB	SD/S 2.16.1

ANALOG DRIVERS AND DIMMERS

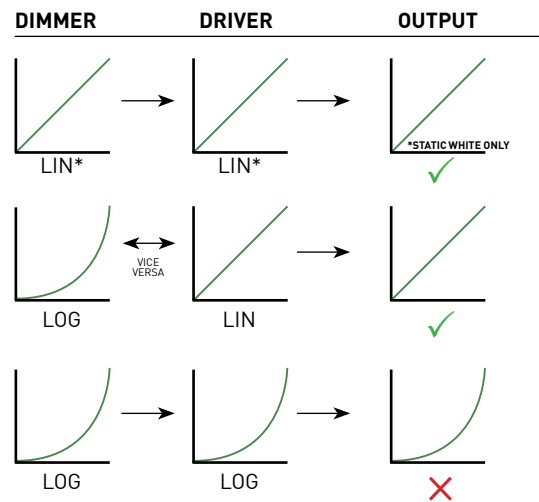

LIN = LINEAR
 LOG = LOGARITHMIC
 *LIN-TO-LIN NOT COMPATIBLE FOR WARM-DIM

