





TRACK HEAD INT MONOPOINT INSPIRED CTM2 WALLWASH

Give the most special art, objects, places, and spaces an elegant wash of soft light, with this classic, easy-to-adjust wallwash track head with an integrated kick reflector.

PROJECT NAME:	TYPE:
---------------	-------



ORDERING INFORMATION - TRACK HEAD

CYLINDER	FIXTURE	STEM LENGTH	RATING	BODY FINISH	BAFFLE FINISH	STEM FINISH	ADAPTER FINISH	LUMEN PACKAGE	CCT	OPTIC(UGR)	DRIVER	MEDIA
CTM2	W	SL	1		BK					WW	IE2	W
CTM2 3.25"	W Wallwash	LENGTHS SL 1.4" Standard * STEMS ARE NOT FIELD CUTTABLE	1 Dry	POWDERCOAT WH White BK Black ALUMINA 01 Brushed Obsidian 02 Matte Obsidian 03 Brushed Dark Patinated Bronze 04 Matte Dark Patinated Bronze 05 Brushed Aged Aluminum 06 Matte Aged Aluminum 07 Brushed Cast Brass 08 Matte Cast Brass 09 Brushed Light Patinated Bronze 10 Matte Light Patinated Bronze 	POWDERCOAT BK Black 	POWDERCOAT WH White BK Black ALUMINA CONSULT FACTORY FOR ALUMINA FINISHES 	WH White BK Black 	STATICWHITE 80S11A 80+ CRI, 11 Watts Delivered Lumens - 819 80S17A 80+ CRI, 17 Watts Delivered Lumens - 1240 90S11A 90+ CRI, 11 Watts Delivered Lumens - 704 90S17A 90+ CRI, 17 Watts Delivered Lumens - 1065 97S11A 97+ CRI, 11 Watts Delivered Lumens - 618 97S17A 97+ CRI, 17 Watts Delivered Lumens - 935 WARM DIM 90W18A 90+ CRI, 18 Watts Incandescent Profile Delivered Lumens - 787 Standard Profile Delivered Lumens - 809 SEE PAGE 3 FOR DETAILED WARM DIM PROFILE COMPARISON. LUMENS DELIVERED REFLECT 3000K.	24 2400K* * (90+ CRI only) 27 2700K 30 3000K 35 3500K 40 4000K WL 2700K - 1800K WD 3000K - 1800K	WW Wallwash Optic (<19)	INTEGRAL IE2 Electronic 2% ELV / TRIAC 220V-240V	W Wallwash Lens

PART NUMBER NOTES

- CTM2 ships as e.g., CTM2WSL1WHBKWH90S17A30WWIE2W

POWDERCOAT FINISHES

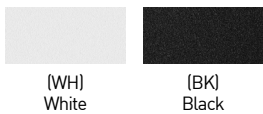

ALUMINA FINISHES BY LUCIFER LIGHTING™



TRACK HEAD INT J-HINGE CTM2 WALLWASH

WALLWASH DESIGN GUIDE

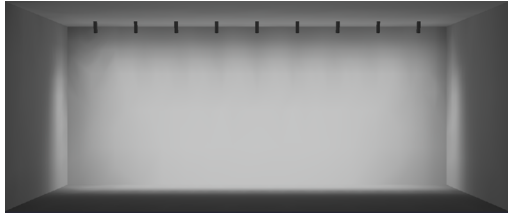

8FT CEILING

36" SETBACK / 36" ON CENTER SPACING / 15° TILT

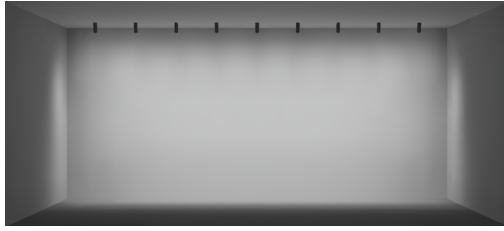

10FT CEILING

36" SETBACK / 36" ON CENTER SPACING / 15° TILT

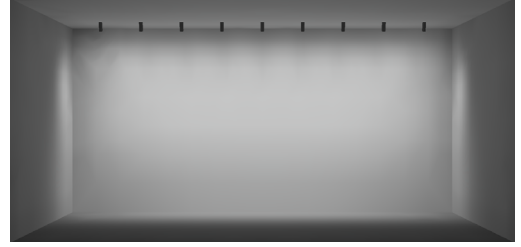

12FT CEILING

36" SETBACK / 36" ON CENTER SPACING / 15° TILT

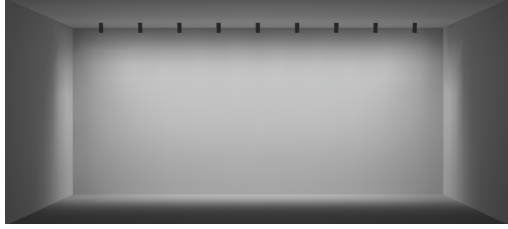

30" SETBACK / 30" ON CENTER SPACING / 10° TILT

- AVERAGE FC: 21.92
- MAX / MIN: 4.65
- 10FT CEILING SHOWN / 8-12FT IDEAL
- 9 FIXTURES / 25FT WALL SHOWN

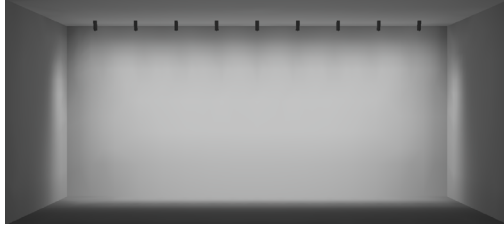

RECOMMENDED

36" SETBACK / 36" ON CENTER SPACING / 15° TILT

- AVERAGE FC: 20.85
- MAX / MIN: 4.12
- 10FT CEILING SHOWN / 8-12FT IDEAL
- 9 FIXTURES / 30FT WALL SHOWN



42" SETBACK / 42" ON CENTER SPACING / 20° TILT

- AVERAGE FC: 19.23
- MAX / MIN: 5.53
- 10FT CEILING SHOWN / 8-12FT IDEAL
- 9 FIXTURES / 35FT WALL SHOWN

ADDITIONAL SETBACKS AND SPACINGS

ON CENTER SPACING	SETBACK / TILT		
	30" / 10° TILT	36" / 15° TILT	42" / 20° TILT
30"	SHOWN ABOVE	AVERAGE FC: 23.92 MAX / MIN: 4.51	AVERAGE FC: 25.96 MAX / MIN: 4.54
36"	AVERAGE FC: 19.19 MAX / MIN: 4.37	SHOWN ABOVE	AVERAGE FC: 22.64 MAX / MIN: 4.03
42"	AVERAGE FC: 16.19 MAX / MIN: 5.87	AVERAGE FC: 17.67 MAX / MIN: 5.74	SHOWN ABOVE

TRACK HEAD INT J-HINGE CTM2 WALLWASH

STATIC WHITE PERFORMANCE - 3000K

LUMEN PACKAGE	WATTAGE	WW OPTIC WALLWASH LENS	
		DELIVERED	LPW
80S11A	11	819	74
80S17A	17	1240	73
90S11A	11	704	64
90S17A	17	1065	63
97S11A	11	618	56
97S17A	17	935	55
90W18AL 2700K-1800K	18	787	49
90W18AD 3000K-1800K	18	809	50

OUTPUT MULTIPLIER

CCT	CCT SCALE
2400K	0.85
2700K	0.97
3000K	1.00
3500K	1.03
4000K	1.08

UNIFIED GLARE RATING

WALLWASH OPTIC
>19

Part L 75+ LPW configurations comply with residential Part L
95+ LPW configurations comply with commercial Part L

WARM DIM PERFORMANCE

INCANDESCENT DIMMING PROFILE

90W18AL 2700K - 1800K	Full on 100%	Dimmed to 80%	Dimmed to 70%	Dimmed to 50%	Dimmed to 20%	Dimmed to 10%	Dimmed to 2%
CCT (K)	2700	2650	2620	2520	2180	1950	1800
Light Output (Lm)	787	630	551	394	157	78.7	16
Power (W)	18	14.4	12.6	9	3.6	1.8	0.36
Efficacy (LPW)	44	44	44	44	44	44	44

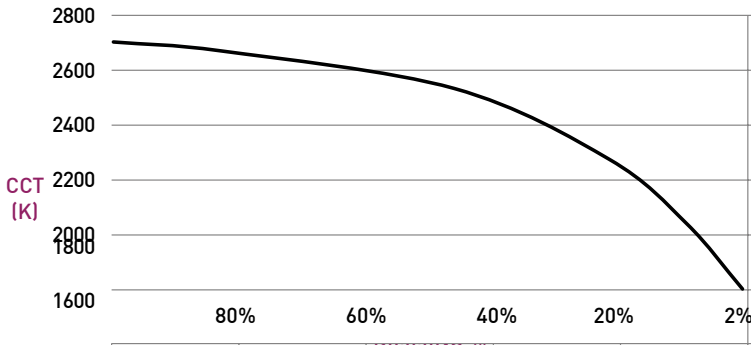

HALOGEN WARM DIM PROFILE

90W18AD 3000K - 1800K	Full on 100%	Dimmed to 80%	Dimmed to 70%	Dimmed to 50%	Dimmed to 20%	Dimmed to 10%	Dimmed to 2%
CCT (K)	3000	2950	2920	2775	2375	2000	1800
Light Output (Lm)	809	647	566	405	162	81	16
Power (W)	18	14.4	12.6	9	3.6	1.8	0.36
Efficacy (LPW)	43	43	43	43	43	43	43

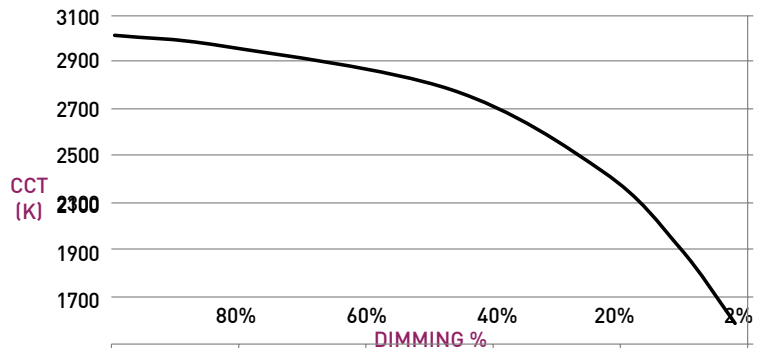

TRACK HEAD INTERNATIONAL CTM2 WALLWASH

TRACK HEAD

- A ADJUSTABILITY**
Up to 90° lockable tilt and 370° lockable rotation.
- B TRACK ADAPTER**
Proprietary asymmetric track adapter; compatible with Lucifer Lighting track only. Available in Black and White finishes to match track systems.
- C STEM**
Standard length is 1.4". Stem is not field cuttable. Powdercoat finishes standard, consult factory for Alumina finishes.
- D BODY**
Power supply integrated into fixture body. Available in powdercoat and Alumina finishes. Body interior **D1** matches exterior finish; interior and exterior finishes cannot be specified differently.
- E OPTIC**
Proprietary optic for optimal wallwashing.
- F MEDIA**
Asymmetrical spread lens, included and sealed in place.
- G BAFFLE**
Baffle minimizes aperture glare and conceals view into fixture. Available in black powdercoat finish.
- H KICK REFLECTOR**
Miro® Kick reflector uniformly spreads light projected to wall plane. Kick reflector not available with painted or Alumina finishes.

DIMENSIONS / DRAWINGS

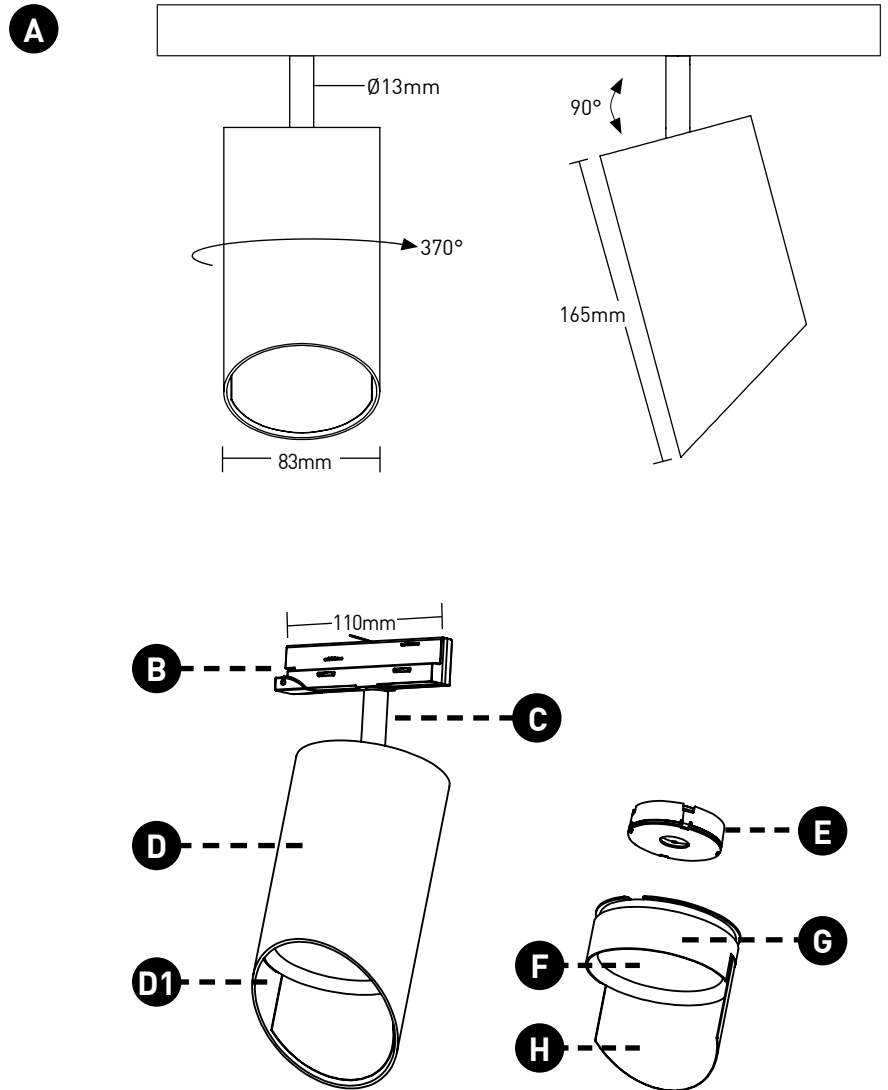

CYLINDER TRACK HEAD INTERNATIONAL CTM2 WALLWASH

TECHNICAL

CONSTRUCTION

Track Head: Machined aluminum body; painted finishes are granulated powder coat; Alumina finishes are anodized aluminum.

STATIC WHITE LED

2-step MacAdam ellipse LED module available in 80+, 90+ and 97+ CRI configurations in color temperatures of 2700K, 3000K, 3500K and 4000K. 3-step MacAdam ellipse LED module available in 90+ CRI configuration in color temperature of 2400K. Average rated lamp life of 50,000 hours.

WARM DIM LED

3-step MacAdam ellipse warm dim LED module available in 90+ CRI configuration. 3000K or 2700K at full brightness, warming to 1800K at full dim. Average rated lamp life of 50,000 hours.

POWER SUPPLY PERFORMANCE AND DIMMING INFORMATION

Power Supply	IE2
Minimum °C	-20 °C
Maximum °C	40 °C
Dimming %	2.0%

MOUNTING

Cylinder track head mounts to recessed, surface or pendant mount track assemblies, specified separately.

SPACING AND TILT

Trackhead must be tilted to achieve wallwashing effect. Recommended fixture spacing is 914mm (36") on center with 914mm (36") setback from wall plane with 15° tilt.

LISTING

Track heads and drivers CE Listed for dry locations. Drivers ENEC and CB Listed.

PART L

Part L compliant for all 75+ LPW residential and 95+ LPW commercial configurations.

LIMITED WARRANTY

Manufacturer's Limited Warranty guarantees product(s) listed to be free from defects in material and workmanship under normal use and service for 1-year. LED and power supplies are warranted to operate with 70% of original flux and remain within a range of 3 duv for a period of 5-years. Warranty period begins from the date of shipment by Seller. [Consult website for full warranty terms and conditions.](#)

CHANGE LOG

- 03/16/2023: REMOVED ALL STEM LENGTH OFFERINGS EXCEPT STANDARD 1.4" LENGTH.
- 05/12/2023: ADDED LBC RED LIST APPROVED.
- 08/08/2023: ADDED NEW LED AND OPTIC SYSTEM.
- 02/08/2024: ADDED 2400K OFFERING.
- 2/15/2024: PART L COMPLIANCE ADDED